

Miele

Operating and Installation instructions



Pyrolytic ovens H 4331, H 4431

To avoid the risk of accidents or damage to the appliance, it is **essential** to read these instructions before it is installed and used for the first time.



M.-Nr. 07 087 910

Description of the appliance	5
Features	6
Accessories	8
Baking tray, grill pan and rack	8
Roasting filter	8
Slide opener	8
Anti-splash tray	9
Handle	9
Caring for the environment	10
Warning and Safety instructions	11
Safety feature	16
Before using for the first time	17
Set the time of day for the first time	17
Cleaning and heating up for the first time	18
Controls	19
Programme selector	19
Display	19
Multi-function selector with turn and press mechanism	20
Functions and symbols in the display	21
Operating sequence	22
Changing the time of day	23
To set the minute minder	24
Description of the oven systems	25
Using the oven	27
Programme selector	27
Selecting a temperature	28
Altering the temperature	28
Using the oven	29
Fan run-on	30
Rapid heat-up	30
To switch "Rapid heat-up" off	31
Pre-heating the oven	31
Entering a cooking duration	32
Symbols in the display	33
Using the residual heat-Energy-save function	34
At the end of the cooking duration	34

Contents

Switching off automatically	35
Switching on and off automatically	36
To check and change an entered time	37
To delete a set time	37
System lock	38
Safety lock	39
Altering oven settings 	41
Baking	45
Baking chart	48
Roasting	50
Roasting chart	52
Grilling	53
Grill chart	55
Defrosting	56
Cooking	57
Gentle bake	57
Cleaning and care	58
Appliance front and control panel	58
Accessories	60
Baking tray, grill pan, anti-splash tray (if fitted), racks and runners	60
Roasting filter	60
PerfectClean	61
Oven interior	63
Pyrolytic cleaning of the oven interior	63
To remove the oven door	66
To dismantle the oven door	67
To refit the door	69
To remove the runners	70
Problem solving guide	71
After sales service	75
Extra accessories	76
Electrical connection UK, IRL, ZA	78
Electrical connection AUS, NZ	80
Installing the oven	81

Description of the appliance

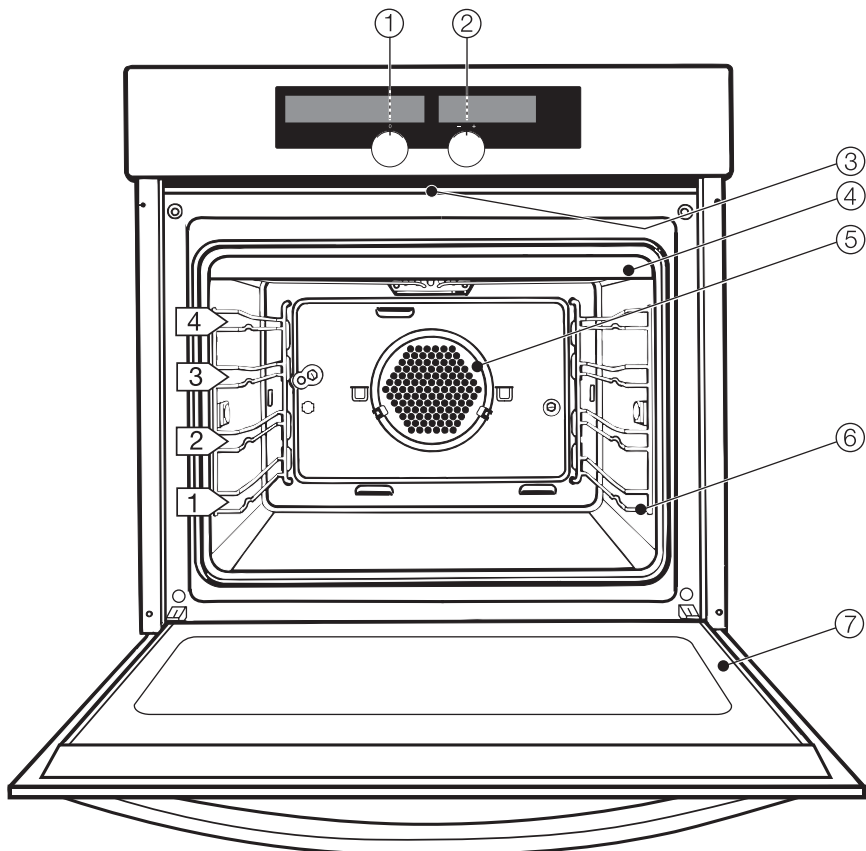

Control panel *

- ① Programme selector, display
- ② Multi-function selector with turn and press mechanism, Display

Oven interior

- ③ Door contact switch, Door lock for pyrolytic operation
- ④ Heating element for top heat and grilling with roof liner
- ⑤ Air inlet for fan
- ⑥ Side runners with 4 shelf levels
- ⑦ Oven door

* style will depend on model

Description of the appliance

Features

Electronic controls

In addition to operating the various cooking programmes to bake, roast and grill the electronic controls also offer the following features:

- Clock display
- Minute minder
- Timer to automatically switch cooking programmes off, or on and off with automatic use made of residual heat
- Settings can be customised.

Safety features

You can activate a **system lock**, to prevent the appliance being used unintentionally. See "System lock" for details.

Safety switch-off is triggered automatically if the oven is operated for an unusually long period of time. The period of time will depend on the particular oven function being used. The oven will switch off automatically and "**F 55**" will appear in the display. The oven can be used again immediately after switching it off and back on.

Cooling system

As soon as the oven is switched on, a cooling fan is automatically engaged. The cooling fan mixes hot air from the oven cavity with cool room air before venting it out into the kitchen through vents located between the appliance door and the control panel.

The cooling fan will continue to run for a while after the oven has been switched off to prevent any humidity building up in the oven, on the control panel or on the oven housing unit.

When the temperature in the oven has fallen sufficiently, the cooling fan will switch off automatically.

Pyrolytic self-cleaning programme

The oven interior can be kept clean by using the Pyrolytic  cleaning programme.

This programme heats the oven interior up to 460 °C. Any residual soiling is broken down and reduced to ash by the high temperatures.

For safety reasons the door is locked at the beginning of the pyrolytic programme.

This oven offers three programme durations for pyrolytic cleaning.

- **Py 1** lasting approx. 2 hours 15 mins
- **Py 2** lasting approx. 2 hours 35 mins
- **Py 3** lasting approx. 2 hours 55 mins

For safety reasons the door will remain locked until the temperature in the oven cavity has dropped below 280 °C.

See "Cleaning and care" for more information.

Description of the appliance

PerfectClean treated surfaces

The following surfaces are all treated with PerfectClean enamelling:

- Runners
- Baking tray
- Grill pan
- Rack

PerfectClean enamelled surfaces have very good anti-stick properties and are much easier to keep clean than conventional enamel, if cleaned regularly.

See "Cleaning and care" for more information.

Door contact switch

There is a door contact switch located centrally underneath the control panel. If the door is opened during operation, the door contact switch causes the oven heating, and the fan, depending on which oven function is operating, to switch off.

This helps reduce the amount of heat lost from the oven cavity, e.g. when checking food.

Vented oven door

The oven door is made up of a total of four panels. There is an opening at the top and bottom of these.

During operation cool air is passed through the oven door to keep the outer panel cool and safe to touch.

If necessary the oven door can be dismantled for cleaning. See "Cleaning and Care".

Retractable controls

All controls are retractable. Press them to release or retract them.

Energy efficiency rating according to EN 50304

These appliances are rated energy efficiency class **A** in accordance with EN 50304. Tests were carried out using Gentle bake.

Description of the appliance

Accessories

The following accessories are supplied with this oven.

These and other accessories are also available to order from the Miele Spare Parts Department, your Miele Dealer or via the Internet (depending on country). See "Extra accessories" further on in this booklet for more details.

Baking tray, grill pan and rack

The baking tray, grill pan and rack are fitted with non-tip safety notches which prevent them being pulled right out when they only need to be partially pulled out.

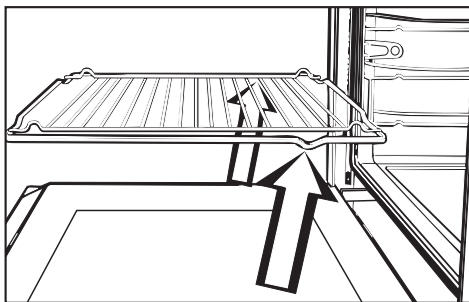

When pushing the tray, pan and rack back in, always ensure that the safety notches are at the rear of the oven (see illustration).

The tray, pan and rack can then only be taken out of the oven by raising them upwards and then pulling them out.

Roasting filter

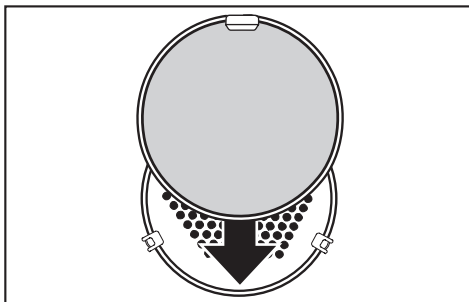

The roasting filter must be fitted in front of the fan when cooking anything fatty, or where food is likely to splatter, e.g. when open roasting or grilling meat.

The droplets of fat caught up in the circulating air are deposited on the roasting filter. This helps to keep the oven and the area behind the interior back panel cleaner.

Do not use the roasting filter when baking. This would increase the times needed for baking and give uneven browning results.

Slide opener

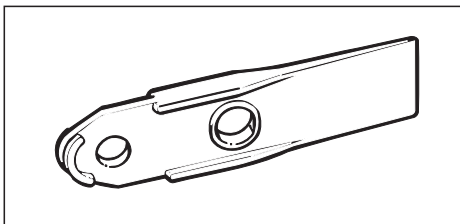

Use the slide opener for lifting off the light cover.

Description of the appliance

Anti-splash tray

(depending on model)

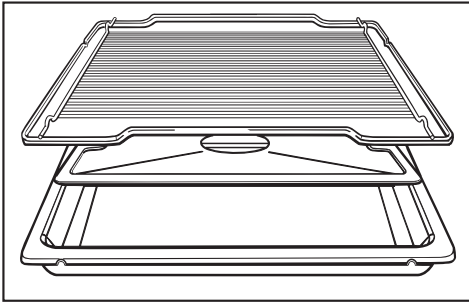

The anti-splash tray should be placed in the deep-sided grill pan when grilling or roasting.

The juices from the food being cooked collect under the anti-splash tray. This prevents them from spitting and making the oven dirty. The juices can then be used for making gravy and sauces.

Handle

(depending on model)

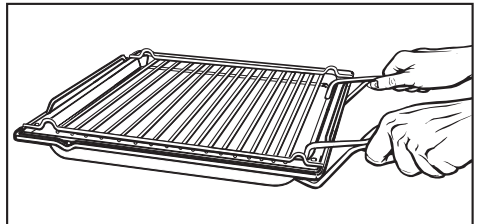
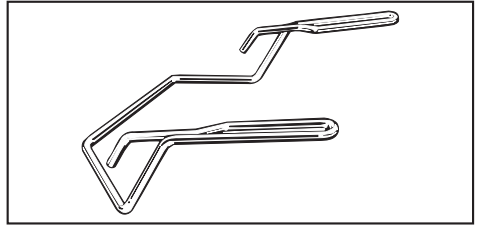

The handle makes it easier to take the baking tray, grill pan and rack out of the oven, or to put them into it.

The two prongs at the top go inside the pan, rack or tray and the U-shaped supports underneath.

Caring for the environment

Disposal of the packing material

The transport and protective packing has been selected from materials which are environmentally friendly for disposal and can normally be recycled.

Ensure that any plastic wrappings, bags etc. are disposed of safely and kept out of the reach of babies and young children. Danger of suffocation!

Rather than just throwing these materials away, please ensure they are offered for recycling.

Disposal of your old appliance

Electrical and electronic appliances often contain materials which, if handled or disposed of incorrectly, could be potentially hazardous to human health and to the environment. They are, however, essential for the correct functioning of your appliance. Please do not therefore dispose of it with your household waste.

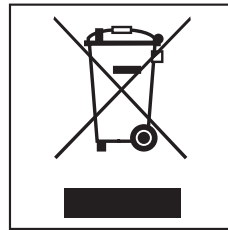

Please dispose of it at your local community waste collection / recycling centre and ensure that it presents no danger to children while being stored for disposal.

It should be unplugged or disconnected from the mains electricity supply by a competent person.

Warning and Safety instructions

This appliance complies with all relevant legal safety requirements. Improper use of the appliance can, however, present a risk of both personal injury and material damage.

To avoid the risk of accidents and damage to the appliance, please read these operating instructions carefully before installation and before using it for the first time. They contain important notes on installation, safety, operation and care of the appliance.

Keep these instructions in a safe place and pass them on to any future user.

Correct usage

■ This appliance is intended for domestic use to cook food, and in particular to bake, roast, defrost, cook, dry fruit etc, and to grill. Any other usage is at the owner's risk and could be dangerous. The manufacturer cannot be held liable for damage caused by incorrect or improper use of the appliance.

■ This appliance is not intended for use by persons (including children) with reduced physical, sensory or mental capabilities, or lack of experience and knowledge, unless they have been given supervision or instruction concerning use of the appliance by a person responsible for their safety.

■ Children should be supervised to ensure that they do not play with the appliance.

Technical safety

■ Before connecting the appliance to the mains supply, make sure that the voltage and frequency correspond to the rating on the data plate, otherwise the appliance could be damaged. Consult a competent person if in doubt.

■ The electrical safety of this appliance can only be guaranteed when continuity is complete between it and an effective earthing system which complies with local and national safety regulations. It is most important that this basic safety requirement is present and regularly tested, and where there is any doubt the household wiring system should be inspected by a qualified electrician.

The manufacturer cannot be held liable for the consequences of an inadequate earthing system (e.g. electric shock).

■ The appliance must be built in before operation to ensure that no electrical components are accessible.

■ Never open the casing of the appliance.

Tampering with electrical connections or components and mechanical parts is highly dangerous to the user and can cause operational faults.

Warning and Safety instructions

Installation, maintenance and repair work may only be carried out by a suitably qualified and competent person in accordance with national and local safety regulations.

Repairs and other work by unqualified persons could be dangerous. The manufacturer cannot be held liable for unauthorised work.

If the supply cord is damaged, it must be replaced by a Miele approved service technician in order to avoid a hazard.

During installation, maintenance and repair work, the appliance must be disconnected from the mains electricity supply. The appliance is only completely isolated from the electricity supply when:

- the mains fuse is withdrawn,
- or the screw-out fuse is removed (in countries where this is applicable),
- or it is switched off at the isolator.

Ensure that current is not supplied to the appliance until after maintenance or repair work has been carried out.

Do not connect the appliance to the mains electricity supply by an extension lead.

Extension leads do not guarantee the required safety of the appliance (e.g. danger of overheating).

This equipment may only be used in mobile installations such as ships, caravans, aircraft etc. if a risk assessment of the installation has been carried out by a suitably qualified engineer.

In countries where there are areas which may be subject to infestation by cockroaches or other vermin, pay particular attention to keeping the appliance and its surroundings in a clean condition at all times. Any damage which may be caused by cockroaches or other vermin will not be covered by the appliance guarantee.

Use

Caution, danger of burning.
High temperatures are produced by the oven.

Great care should be taken to ensure that small children do not touch the appliance when it is being used. Children's skin is far more sensitive to high temperatures than that of adults.

External parts of the oven such as the door glass, handle vent and control panel can become quite hot.

Children should not be left alone or unattended in an area where an oven is in use. They should never be allowed to sit or stand on any part of the oven or play with it.

Do not store items of interest to children in cabinets above an oven. Children climbing on to the oven to reach these could be seriously injured.

Warning and Safety instructions

■ Use oven gloves when placing food in the oven, turning or removing it and when adjusting shelves etc in a hot oven.

When using "Conventional" heating or when grilling the element in the roof of the oven and the roof liner become very hot.

■ The oven door gets much hotter during pyrolytic operation than during normal use.

Make sure children cannot touch the oven whilst a pyrolytic programme is running. Danger of burning.

■ Remove all accessories as well as the runners and any extra accessories such as, for example, the baking carriage, or telescopic runners from the oven interior before starting the pyrolytic cleaning process. The high temperatures needed for pyrolysis will damage the accessories and cause irreparable damage to the baking carriage and telescopic runners.

■ Do not use plastic containers. These melt at high temperatures and could damage the oven.

■ Do not heat up unopened tins or jars of food in the oven, as pressure can build up and they may explode resulting in injury or damage.

■ Do not push pots and pans around on the oven floor, as this could damage the surface.

■ Do not lean or sit on an open oven door, or place heavy items on it. This could damage the appliance. The oven door can support a maximum load of 15 kg.

■ To prevent the risk of damage when closing the oven door, hold the handle firmly and do not let go of it until it is shut. Make sure that nothing gets trapped between the door and the oven.

■ Cover any food which is left in the oven to be kept hot. Any moisture in the food could lead to corrosion damage in the oven. This also prevents the food from drying out.

■ If you wish to complete a cooking process using the residual heat in the oven, do not switch the appliance off.

Leave the programme selector at the position set and select the lowest temperature.

Do not switch the appliance off until the food has been removed. Moisture in the oven could lead to condensation forming on the control panel and surrounding kitchen furniture and drops of moisture collecting under the worktop.

Condensation can:

- damage the housing unit / worktop.
- lead to corrosion in the oven.

On models fitted with a catalyser, it could also result in deposits remaining in the catalyser, causing an unpleasant smell to arise the next time the appliance is switched on.



Warning and Safety instructions

■ Bake larger frozen products, such as pizzas, on baking paper on the rack itself or in the pizza pan (see "Extra accessories").

Placing them on the baking tray or in the grill pan can cause the metal to distort, and this distortion will increase with each subsequent use.

Frozen food such as oven chips or croquette potatoes can, however, be cooked on the baking tray or in the grill pan.

■ Never add water to food on a hot baking tray or grill pan or directly onto food in a hot oven. The steam created could cause serious burns or scalding and the sudden change in temperature can damage the enamel.

■ Never line the floor of the oven with aluminium foil when using Conventional  or Bottom heat  or Intensive bake , or place a dish, tin, baking tray or grill pan on the floor of the oven.

If using a grill pan or baking tray made by a different manufacturer, make sure that there is a gap of at least 6 cm between the bottom of the pan and the floor of the oven.

If these instructions are not observed the bottom heat will be blocked. This can cause permanent damage to the floor of the oven.

■ Protective aluminium foil panels are available in retail outlets which are supposed to protect the oven cavity from soiling and reduce the need for cleaning. If used, cooking and baking times will increase considerably. They can also cause damage to the appliance (e.g. by blocking the heat).

General notes

■ Never leave the appliance unattended when cooking with oil or fats, as these are a fire hazard if allowed to overheat.

■ Do not use the oven to heat up the room. Due to the high temperatures radiated, objects left near the oven could catch fire.

■ Always ensure that food is sufficiently cooked or reheated. Many factors will affect the overall cooking time, including the size and amount of food, its temperature, changes to the recipe and the shape and size of cooking container. Some foods may contain micro-organisms which are only destroyed by thorough cooking at temperatures over 70 °C for a minimum of 10 minutes. Therefore when cooking or reheating foods, e.g. poultry, it is particularly important that food is fully cooked through. If in doubt select a longer cooking or reheating time.

It is important that the heat is allowed to spread evenly throughout the food being cooked. This can be achieved by stirring and/or turning the food during cooking.

Warning and Safety instructions

■ When using kitchen appliances connected to sockets near the oven, ensure that the cable cannot get trapped in a hot oven door, which could melt the cable insulation. Danger of electric shock.

■ Never use a steam cleaner to clean the appliance. The steam could reach electrical components and cause a short circuit.

■ If using alcohol in your recipes, high temperatures can cause the alcohol to vaporise and even to ignite on the hot heating elements. Alcohol should be burnt off before the dish is placed in the oven to avoid this danger.

Disposal of your old appliance

■ Before throwing an old appliance away it must first be made unusable. Switch off and disconnect it from the power supply. This should be done by a competent person. If connected to an isolator switch, disconnection should be carried out by an electrician to avoid the risk of accidents.

The manufacturer cannot be held liable for damage caused by non-compliance with these Warning and Safety instructions.

Safety feature

Door lock for pyrolytic mode

For safety reasons the door is automatically locked at the beginning of the pyrolytic programme.

At the end of the programme it will not be unlocked until the temperature inside the oven has dropped to below 280 °C.

If the Pyrolytic  cleaning programme has been started by mistake or if the process is interrupted, the door lock will be released:

- immediately if the temperature is below 280 °C.
The door can then be opened about 30 seconds later.
- not until the oven interior temperature is below 280 °C if the temperature inside the oven is higher than 280 °C.

Before using for the first time

The oven is supplied with the controls pushed in. They have to be released before the oven can be used.



After installation and before using the oven for the first time the **clock has to be set**.

When the oven is first switched on the clock will show 12:00 until you have set the correct time.

The display will go dark about 30 seconds after entering the time of day. The time will continue to run in the background. The time can also be set to show constantly in the display. See "Altering oven settings  - P 1".

Set the time of day for the first time

The time can only be entered when the programme selector is at "0".

"12:00" and the  (time of day) and  symbols will light up.

The clock has a 24 hour display.



■ Press the multi-function selector gently.

"12:00" and triangle  underneath the  symbol will start flashing.

■ Turn the multi-function selector clockwise or anti-clockwise to display the hour required.

■ Press the multi-function selector gently.

This confirms the hour and the minutes will then start to flash.

■ Turn the multi-function selector clockwise or anti-clockwise to display the minutes required.

■ Press the multi-function selector gently.

This confirms the minutes.

When the time has been entered, the display goes dark and the clock runs in the background.

The time will appear again in the display as soon as you press or turn the multi-function selector.

Before using for the first time

Cleaning and heating up for the first time

Before use, please remove

- any stickers from the floor of the oven, baking trays, grill pan etc.
- the protective cork discs from the sides of the oven.
- any protective foil from the oven front.

See "Cleaning and care" for more information.

Before using the oven for the first time

- take **all accessories** out of the oven and wash them.
- then **heat the oven up once with nothing in it**. New ovens have a slight smell on first use and this will dissipate the smells before you use it to cook any food.
- Before heating it up it is a good idea to wipe the oven out with a damp cloth first. This way any dust or bits of packaging that may have accumulated in the oven cavity during storage and unpacking will be removed.
- Press and release the programme selector and the multi-function selector.
- Turn the Programme selector to the Fan plus  setting.



The recommended temperature 160 °C will then appear in the display.

- Whilst the triangle ▲ is flashing underneath the  symbol, use the multi-function selector to set the temperature to its highest setting (250 °C).

Once this setting has been confirmed

- the oven heating will switch on,
- and the actual temperature in the oven will show in the display.

Heat the empty oven up for at least an hour.

Please ensure that the kitchen is well ventilated during this operation.





Close doors to other rooms to prevent the smell spreading throughout the house.

- Wait until the oven has cooled down to room temperature.
- Then wipe out the oven cavity with a solution of hot water and a mild detergent and then dry it thoroughly with a clean cloth.

Leave the oven door open until the oven interior is completely dry.

The timer can also be used to set the finish time. See "Entering a cooking duration - Switching off automatically".

The oven controls consist of:

- the **Programme selector**, for selecting oven functions with, e.g. Lighting , Fan plus , Auto roast , ...
- the **Multi-function selector with press and turn mechanism** for selecting oven functions which require input e.g. the time of day , cooking durations , ...
- the **Display**, where all changes and settings are visible.

Programme selector

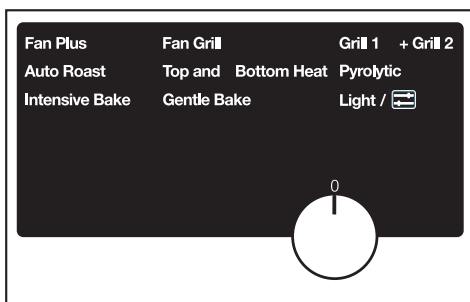
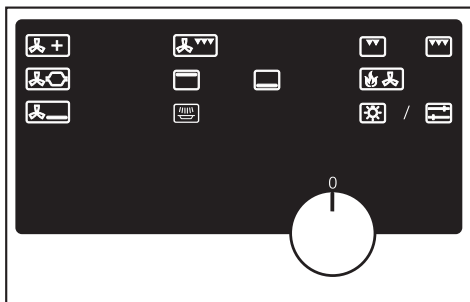

The programme selector is used for selecting your cooking function. It can be turned clockwise or anti-clockwise.

Display



The **bottom line** shows the **Symbols of functions where data can be changed**.

The **triangle ▲** will appear in the display underneath the symbol of the function you have selected.

The **top line** shows:

- the time (time of day or a programmed cooking time).
- the oven temperature.
- the key symbol  will appear if the system lock is on or the programme selector is turned when a cooking programme has been locked using the programme lock.
- "E" for residual heat being used.

Controls

Multi-function selector with turn and press mechanism

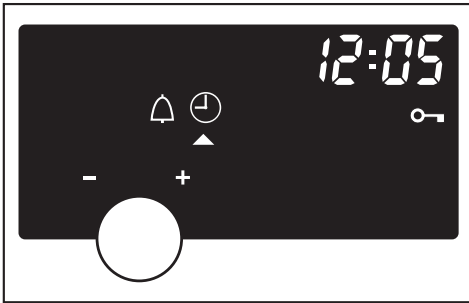

To **select a function**, turn the multi-function selector until **triangle ▲ is underneath the required symbol** in the display of the function you wish to make changes to.

Then press the multi-function selector to confirm your choice.

If **triangle ▲**

- **is flashing**, alterations can be made to the settings of the function selected.
- **is lit up**, the function will be displayed, but changes cannot be made to it.

Whilst triangle ▲ is flashing, use the **multi-function selector** to make any changes:

- **Turning it clockwise**, increases the value shown or engages the function,
- **Turning it anti-clockwise**, reduces the value or switches the function off.

The triangle ▲ will flash for approx. 5 seconds.
Settings can only be changed while it is flashing.
If this period has elapsed you will have to call up the required symbol again.

Press the multi-function selector to confirm your choice.

See the chart for an overview of symbols in the display and their settings.













The display will change at a different rate depending on how quickly the selector is turned:

- in one minute increments
- in 10 minute increments or
- hour by hour.

Functions and symbols in the display

Different functions can be called up depending on the position of the programme selector.

This chart gives an overview of these settings.

Symbol	Programme selector setting		
	Position "0"	Light  / 	Function
	Changing the time of day	–	–
	Setting the minute minder	Setting the minute minder	Setting the minute minder
 *	Switch the system lock on or off	–	Lock a cooking programme
	–	–	Change the oven temperature
 *	–	–	Switch Rapid heat off (applies to Fan plus  , Auto roast  and Conventional heat  only)
	–	–	Enter a start time
	–	–	Enter a duration
	–	–	Enter a finish time

* The symbol will only appear in the display if the respective function has been selected (see section "Altering oven settings ").

Operating sequence

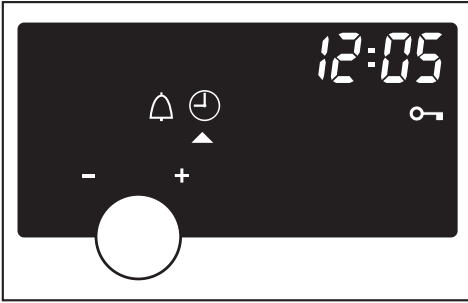

Temperatures, times and other functions are controlled using two rotary dials:

Entries made are shown in the display.

To change a setting on the oven:

- Turn the **programme selector** to the required position.
- Then turn the **multi-function selector**.

All functions which can be set or changed will appear in the display.

- Turn the **programme selector** clockwise or anti-clockwise until triangle ▲ is underneath the required symbol in the display.
- Press the **multi-function selector** gently.

The function is now selected and the triangle ▲ underneath required symbol will start **to flash**.

- Whilst **the triangle ▲ is flashing**, use the multi-function selector immediately to make any changes.

The triangle ▲ will flash for approx. 5 seconds. If this input period has elapsed you will have to re-select the function.

- Press the multi-function selector gently.

This confirms your selection or any changes you have made.

This principle applies whenever you change a setting.

See "Altering the time of day" and "Using the oven" for examples which explain this principle in detail.

Note:

- Times entered are automatically saved after a short period of time without having to press the multi-function selector.
- Any changes to settings, however, have to be confirmed by pressing the multi-function selector.

Changing the time of day

In the following example the time of day is changed from 12:05 to 14:37.

- Turn the function selector to "0".

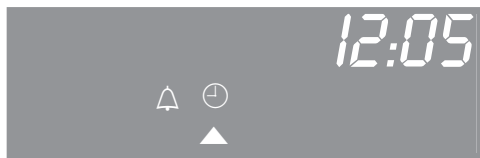

- Turn the multi-function selector (right hand dial) until triangle ▲ is underneath the ⊕ symbol in the display.

- Press the multi-function selector gently.

The hour and the triangle ▲ will start flashing underneath the ⊕ symbol.

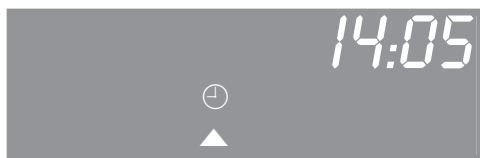

- Turn the multi-function display selector until "74" shows in the display.
- Press the multi-function selector gently.

This confirms the hour and the minutes will then start to flash.

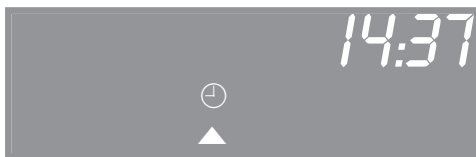

- Turn the multi-function selector until "37" shows in the display.

- Press the multi-function selector gently.

This confirms the minutes.

The symbols go out in a couple of seconds. The time set is now stored in memory.

If the display is set to show the time, the new time of day will show in the display.

To switch the display on or off see "Altering oven settings  - P 1".

The current time of day will reappear even after a power cut.

The appliance stores this information for approx. 200 hours. After that "12:00" will flash in the display as it did when first switched on.

To set the minute minder

The minute minder can be used to time any activity in the kitchen, e.g. boiling eggs.

You can enter a time of up to a maximum of 12 hours.

You can set the minute minder at the same time as another timed programme, e.g. as a reminder to stir a dish or add seasoning etc.

To set the minute minder

- Turn the multi-function selector until triangle ▲ is underneath the △ symbol in the display.
- Press the multi-function selector gently.



"0:00" appears in the display.

- Whilst triangle ▲ is flashing, enter the required duration in hours and minutes using the multi-function selector.

The time entered counts down in minutes until the last minute, which counts down in seconds.

The △ symbol continues to be visible as a reminder that the minute minder is being used.

As long as the △ symbol is selected the minute minder time will be visible counting down in the display.

At the end of the time set for the minute minder

- a buzzer will sound five times in succession.
The standard default setting can be changed if you wish. See "Altering oven settings" – P 2 and P 3.
- the △ symbol flashes for approx. 1 minute.

To cancel the time set for the minute minder

- Call up the △ symbol.
Make sure the triangle is flashing underneath the symbol.
- Whilst triangle ▲ is flashing, set the minute minder time to "0:00" using the multi-function selector.

Description of the oven systems

Fan plus

This system works by the circulation of heated air.

A fan situated in the back wall of the oven draws in the air, heats it over a ring element and blows it back into the oven cavity through the carefully spaced openings in the back panel.

The oven does not usually need to be pre-heated as the heated air reaches the food straight away.

Exception: Pre-heating may be necessary for foods which cook in less than 20 minutes and for foods such as puff pastry and yeast mixtures where instant heat is required to make them rise quickly.

When using Fan plus, you can bake and roast on different levels at the same time.

Lower temperatures can be used than with Conventional top and bottom heating, as the Fan plus system circulates the heated air throughout the oven.

Auto roast

The oven heats initially to a high temperature (230 °C) which seals the meat to keep it succulent and tasty. As soon as this temperature has been reached, the oven temperature automatically drops back down to the pre-selected setting.

Intensive bake

This method combines Fan plus with Bottom heat. It is particularly useful for dishes that require a moist topping and crisp base like pizza and quiche lorraine.

Conventional (top and bottom heat)

With the conventional method of heating, radiant heat is directed onto the food from above and below. It is useful where a fairly long cooking time is required and a deep colour and good rise are needed.

It is usually necessary to pre-heat the oven when using this method.

Description of the oven systems

Gentle bake

Gentle bake uses the fan heat element and the fan.

It is suitable for bakes and gratins where a crispy finish is required.

Grill

Pre-heat the grill for at least 5 minutes with the oven door closed before grilling.

The inner part of the upper heating element acts as the grill. This will glow red for a few minutes after being switched on, and it is then ready for use.

Grill with the oven door closed.

Use this setting for small quantities of food.

Grill - full

Pre-heat the grill for at least 5 minutes with the oven door closed before grilling.

The entire upper heating element acts as the grill.

This method is particularly good for grilling large quantities of food using the grill pan to its full extent.

Grill with the oven door closed.

Fan grill

Pre-heat the grill for at least 5 minutes with the oven door closed before grilling.

The hot air from the grill is distributed over the food by the fan on the back

wall of the oven. This enables a lower temperature to be selected than for conventional grilling.

Grill with the oven door closed.

Pyrolytic cleaning

In this mode the oven cleans itself.

The oven is heated up to approx. 460 °C and any residual soiling in the oven interior is burnt off by the high temperatures.

This oven offers three programme durations for pyrolytic cleaning.

After the cleaning process any pyrolytic debris (e.g. ash) can be easily wiped out.

A function must first be selected using the programme selector and then, if necessary, the temperature changed.

The functions on this oven have pre-set recommended temperatures to simplify operation.

Programme selector

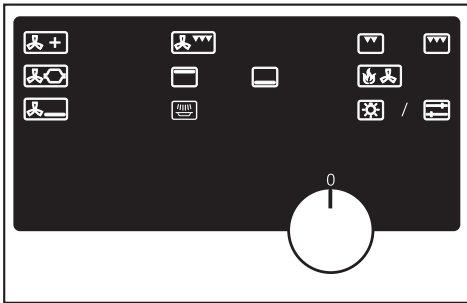

- Turn the programme selector clockwise or anti-clockwise to the required oven function.

The following are available:

- Light / For switching on the oven light independently. Depending on model, oven settings can also be changed when the programme selector is at this position. See "Altering oven settings".
- Fan plus For baking or cooking on several levels at the same time.
- Auto roast This function provides an initial high temperature to seal meat, followed by a lower temperature for continued roasting.

- Intensive bake For recipes which require a moist topping and a crisp base, e. g. cheese cake, pizza, Quiche Lorraine and German style open fruit cakes. It is not suitable for roasting or shallow baking because the base will brown too much.
- Fan grill For grilling thick cuts, e.g. rolled meat, poultry. Grill with the oven door closed.
- Conventional For long, slow baking or traditional recipes, e.g. fruit cake, casseroles.
- Bottom heat Use this setting towards the end of baking, to brown the base of a cake, quiche or pizza.
- Gentle bake For cooking dishes that require a crispy finish, e.g. bakes and gratins.
- Grill For grilling flat items, small quantities, and for browning food in small dishes. Grill with the oven door closed.
- Grill - full For grilling flat items, large quantities, and for browning food in larger dishes. Grill with the oven door closed.
- Pyrolytic For cleaning the oven interior.

Using the oven

Selecting a temperature



As soon as a cooking function is selected, a **recommended temperature** will appear in the display.

If you are happy with the recommended pre-set temperature, the display will change a few seconds later to show this as the **target temperature**.

The oven will then start heating up.

The display will then change to show the **actual temperature** in the oven, and depending on which function is being used the symbol or will also show.

The increase in temperature can be followed in the display until the target temperature is reached.

If the door is opened or the target temperature reduced during cooking, the actual temperature will also go down in the display.

The following recommended temperatures are set at the factory:

Fan plus	160 °C
Auto roast	160 °C
Intensive bake	170 °C
Conventional	180 °C
Bottom heat	190 °C
Fan grill	200 °C
Grill	240 °C
Grill - full	240 °C
Gentle bake	190 °C

* Initial temperature approx. 230 °C, then drops to 160 °C for continued roasting

Altering the temperature

If the temperature recommended by the system is not suitable, it can be altered according to oven function within the following range:

Fan plus	30 – 250 °C
Auto roast	100 – 230 °C
Intensive bake	50 – 250 °C
Conventional	30 – 280 °C
Bottom heat	100 – 250 °C
Fan grill	50 – 260 °C
Grill	200 – 300 °C
Grill - full	200 – 300 °C
Gentle bake	100 – 250 °C

To switch it off:

■ Turn the multi-function selector (right hand dial) until the triangle is underneath the or symbol in the display.

■ Press the multi-function selector gently.

The function is now selected and triangle will start flashing.

■ Turn the multi-function selector until the required temperature shows in the display.

If you have already entered times for a programme, you will first have to call up the or symbol in the display before you can alter the temperature.

Using the oven

Below is an example of setting a simple programme.

To bake a cake using Fan plus , 150 °C.

- Place the cake in the oven and close the door.
- Turn the programme selector to the Fan plus  position.



The recommended temperature 160 °C will then appear in the display.



- Whilst triangle ▲ is flashing use the multi-function selector to reduce the temperature to 150°.



Once this setting has been accepted

- the actual temperature in the oven will be displayed,
- the oven heating will switch on,
- and the cooling fan will switch on.

Take the cake out of the oven when it is ready.

- Turn the programme selector to "0".

Using the oven

Fan run-on

The cooling fan will continue to run for a while after the oven has been switched off to prevent any humidity building up in the oven, on the control panel or on the oven housing unit.

The cooling fan is set up on **temperature control** as standard. It switches off automatically once the oven temperature has dropped to about 70 °C.

The oven will cool down faster if the door is left partially or fully open.

The standard default setting for the cooling fan can be changed to **timed control** if you wish. See "Altering oven settings"  - P 8".

On timed control it switches itself off automatically after approx. 25 minutes.

Do not leave food in the oven to keep it warm if you have set the cooling fan to timed operation. Moisture levels in the oven could increase, leading to condensation forming on the control panel and surrounding kitchen furniture and drops of moisture collecting under the worktop.



Condensate can

- damage the housing unit / worktop.
- lead to corrosion in the oven.

Rapid heat-up

The appliance is supplied with the Rapid heat-up function activated as standard (factory default setting).

With the following functions:

- Fan plus 
- Auto roast 
- Conventional 

the top element, the fan element and the fan will come on during the heating-up phase to enable the oven to reach the required temperature as quickly as possible.



If the  symbol shows in the display Rapid-heat up is active.

The  symbol will appear in the display for all functions which do not have rapid heat-up.

To switch "Rapid heat-up" off

Rapid heat-up should not be used for some items such as biscuits and small cakes because they will brown too quickly from the top.

To switch it off:

- Call up the  symbol.
- Reduce the temperature to 100 °C.

The arrow next to the  symbol will go out.

- Re-set the temperature to the setting you want.

Rapid heat-up is now switched off for this particular cooking process.

Rapid heat-up is available again once the programme selector has been turned to "0" at the end of a cooking process.

The standard default setting can be changed permanently if you wish. See "Altering oven settings -  - P 5"

Pre-heating the oven

Most dishes can be placed in a cold oven. They will then make use of the heat produced during the heating-up phase.

It is only necessary to pre-heat the oven in certain instances.

With **Fan plus** 

- Pre-heat the oven for foods which cook in less than 20 minutes and for foods such as puff pastries and yeast mixtures where instant heat is required to make them rise quickly.

With **Conventional** 

- Pre-heat the oven where a fairly long cooking time is required and a deep colour and good rise are needed.

Rapid heat-up should be switched off when baking delicate items such as pizza, biscuits and small cakes. Otherwise they will get brown too quickly.

Entering a cooking duration

You can programme cooking durations in this oven. Cooking processes are then controlled so that the oven will switch off, or on and off automatically.

You can set the timing for a cooking function, by selecting one of the symbols and entering a time.

Duration \Rightarrow



Select the \Rightarrow symbol to enter the duration of a cooking programme. Once the time set has elapsed, the oven will switch itself off automatically. The maximum length of time which can be set is 12 hours.

Start \Rightarrow



Select the \Rightarrow symbol to specify the time you want cooking to start. The oven will switch on automatically at the time you have set.

Finish \Rightarrow



Select \Rightarrow and specify the time at which you want cooking to end. The oven will switch off automatically at the time you have set.

Entering a cooking duration

Symbols in the display

In addition to the \ominus and \downarrow symbols the symbols representing the duration, start and finish time are also displayed constantly if times have been entered for a cooking programme.

If you have only entered the **duration** (e. g. 1 h. 30 min.) the display will show:



- the actual temperature
- the \downarrow , \oplus and \Rightarrow symbols.

The triangle \blacktriangle underneath the \Rightarrow symbol indicates that a programme duration is being displayed. The time will count down in the display.

To view the required temperature \downarrow or the time of day \oplus in the display you will have to move triangle \blacktriangle underneath the respective symbol.

As soon as the multi-function dial is turned all functions which can be called up or altered are displayed.

To **switch a programme on and off automatically** there are several ways of entering the times:

- enter the duration \Rightarrow and the finish time \rightarrow
- enter the Start \Rightarrow time and the duration \Rightarrow
- enter the Start \Rightarrow time and the finish time \rightarrow

The time which has not been entered is calculated automatically.

The \downarrow and \oplus symbols will show in the display together with the symbols representing times entered e.g. Duration and End time:

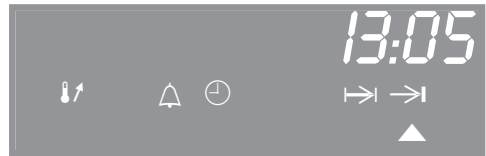

The triangle \blacktriangle underneath the symbol indicates the last time that was entered.

To see the other times entered move the triangle under the respective symbol.

Entering a cooking duration

Whilst **a programme is running** the following show in the display



- the actual temperature
- Duration or Finish time

Using the residual heat-Energy-save function

Shortly before the end of a programme the heating elements will be switched off automatically. The residual heat is sufficient to finish cooking.

Using the residual heat in the oven saves energy.

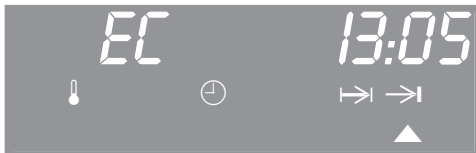



"EC" will appear in the display to show that the oven is in **energy save** mode. The actual temperature is no longer visible.

The cooling fan continues to run, as does the hot air fan if a "fan" setting had been chosen.

The oven heating will switch on again if:

- the required temperature is altered.
- the cooking duration is lengthened significantly.

At the end of the cooking duration

- the oven heating switches off automatically.
- a **buzzer** will sound five times in succession. If the buzzer is not switched off it will continue to sound at 5 minute intervals as a reminder that cooking time has finished. This reminder will carry on for up to an hour. The standard default setting can be changed if you wish. See "Altering oven settings"  - P 2 and P 3.
- the  symbol flashes,
- the **cooling fan** will continue to run for a while.

Both the audible tone and the visual display can be cancelled by:

- pressing the multi-function selector. If the food is not cooked to your taste, you can increase the cooking duration.
- Turn the multi-function selector to "0".

Entering a cooking duration

Switching off automatically

To switch a programme off automatically a duration has to be entered. The following example shows the programming for a cake using Fan plus  at 160 °C for 45 minutes.

- Place the cake in the oven and close the door.
- Select the Fan plus and set the temperature.



- Turn the multi-function selector until triangle ▲ is underneath the  symbol in the display.
- Press the multi-function selector gently.



"0:00" and the actual temperature in the oven (e.g. 23 °C).will appear in the display.



- Whilst triangle ▲ is flashing, enter the required duration in hours and minutes.



After entering the data

- the temperature rise can be followed in the display,
- as well as the duration counting down in minutes, if no other functions are called up. The last minute will count down in seconds.

Entering a cooking duration

Switching on and off automatically

It is a good idea to set the oven to switch on and off automatically when roasting.

When baking, the oven should not be set to start a long time off. Otherwise the batter or dough will dry out, and the raising agents will lose their effectiveness.

An example is used here to explain the procedure:

The time is 9:05. A roast needs 1 h 20 min using Auto roast  at 160 °C and needs to be ready at 13:20.

- Place the dish in the oven and close the door.
- Select Auto roast and set the temperature.

First enter the **duration** :

- Turn the multi-function selector until triangle ▲ is underneath the \rightarrow symbol in the display.
- Press the multi-function selector gently.

"0:00" and the actual temperature in the oven (e.g. 23 °C) will appear in the display.



- Whilst triangle ▲ is flashing, enter the required duration in hours and minutes.

Then set the **end time**:

- Turn the multi-function selector until triangle ▲ is underneath the \rightarrow symbol in the display.



The time of day plus the cooking duration entered appear in the display (9:05 + 1:20 = 10:25).



- Enter the end time (13:20) in Hours:Minutes.

Once this setting has been entered

- the oven heating and cooling fan switch off,
- the \rightarrow and \rightarrow symbols indicate that a programme has been set.

Entering a cooking duration

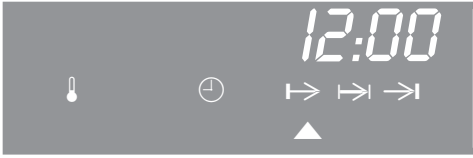

The **Start time** (13:20 - 1:20 = 12:00 h) will show in the display, when you call up the **→** symbol.

The oven will start heating up at this time and the duration will then be displayed.

Important:

In addition to the options given, you can also enter the start and finish time, or just the finish time, using the appropriate symbols.

To check and change an entered time

It is possible to check or change times entered for a cooking programme at any time by calling up the relevant symbol.

To delete a set time



- Turn the programme selector to "0".



If there is a power cut, all data entered will be deleted.

System lock

This oven is equipped with a **System lock**. This prevents the oven being switched on unintentionally, by children for example.

To activate the system lock

The system lock cannot be activated until you have activated **P 4**. See "Altering oven settings ". If activated the  symbol will show in the display when the multi-function selector is turned.

- Turn the programme selector to "0".
- Turn the multi-function selector until triangle  is underneath the  symbol in the display.
- Press the multi-function selector gently.



Four horizontal bars will appear in the display.

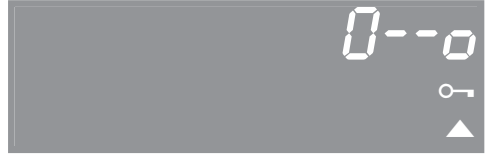

- Turn the multi-function selector clockwise.

A key **0--0** symbol will appear in the display to show that the system lock has been activated

The oven can now not be switched on.

The key symbol "**0--0**" will go out after a short time.

It will light up again if the selector is turned.

The system lock remains active even after a power cut.

To cancel the system lock:

- Turn the programme selector to "0".
- Call up the  symbol.

The key "**0--0**" symbol will appear in the display.

- Turn the multi-function selector anti-clockwise.

The system lock is de-activated when the four horizontal bars appear in the display.

This oven is also equipped with a **Safety lock**. Activating this lock prevents settings being changed during a programme.

To activate the safety lock

The safety lock cannot be activated until you have activated **P 4**. See "Altering oven settings" . If activated the  symbol will show in the display when the multi-function selector is turned.

- Select the programme and set a temperature. If necessary set the cooking duration.

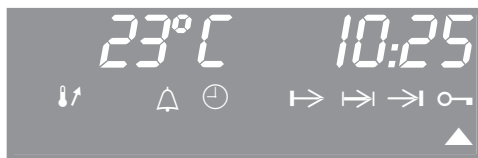

- Turn the multi-function selector until triangle ▲ is underneath the  symbol in the display.
- Press the multi-function selector gently.





Four horizontal bars will appear in the display.



- Turn the multi-function selector in a clockwise direction until a key symbol "" appears in the display.

The programme is now locked.

The key symbol "" will shortly disappear and the time of day appear in the display. The  symbol in the bottom line of the display acts as a reminder that the safety lock has been engaged.

If the multi-function selector is turned, the key "" will appear briefly in the display in place of the time of day.

If the programme selector is turned to a different programme there will also be a continuous shrill beep.

Safety lock

The **cooking programme will stop**, if

- the programme selector is not turned back to the original programme setting within 10 seconds.
- the programme selector is turned to "0".

Turning the programme selector to the "0" position at the end of a locked programme, or after interrupting a programme will not release the safety lock.

In order **to start a cooking programme again** you will have to

- Turn the programme selector to "0".
- De-activate the safety lock/system lock. Call up symbol , and turn the multi-function selector anti-clockwise until four horizontal bars appear in the display.

De-activating the safety lock

Temperatures and times cannot be changed during a programme if the safety lock has been activated.

To switch it off:

- Call up the  symbol.
- Turn the multi-function selector anti-clockwise until four horizontal bars appear in the display.

The safety lock has now been de-activated and you can change settings.



Altering oven settings

Some of the standard oven settings (which are set at the factory) have an alternative which you can select if required.

See the chart over for a list of these settings.

The factory default settings are indicated by a star *.

Proceed as follows:

- Turn the programme selector to the Light /  position.
- Press the multi-function selector gently.



"P I" will appear in the display.

You can make changes to settings ("P I" to "P II").

To do this:

- Turn the multi-function selector clockwise until the required number is shown in the display. Then press it gently to confirm your selection.



"5" appears in the display to let you know that this setting can be altered.

- Turn the multi-function selector until the required setting is shown in the display. Then press it gently to confirm your selection.

The change is then stored in memory.

"P" will appear in the display again together with the number for the oven setting.





You can make changes to further settings as long as you have not turned the multi-function selector back to the "0" position.

The altered settings are retained after a power cut.

Altering oven settings

Oven setting		Settings available (* factory default)
P 1	Clock display	<p>5 0 * The clock display is switched off. The time of day display is switched off when the programme selector is turned to the "0" position. The time of day continues to run in the background. It reappears when the programme selector is turned to one of the functions.</p> <p>5 1 The clock display has been activated. The time is always visible, even when the programme selector is at "0".</p>
P 2	Buzzer	<p>5 0 A buzzer does not sound after the set times have elapsed.</p> <p>5 1 A buzzer sounds after the set times have elapsed.</p> <p>5 2</p> <p>5 3 * There are three buzzer tones to choose from. Turn the multi-function selector to hear to the different tones.</p>
P 3	Buzzer duration	<p>5 0 * At the end of a set time five short beeps sound and are repeated every five minutes. This reminder continues for up to an hour.</p> <p>5 1 A continual beep sounds after a set time has elapsed.</p>
P 4	System lock / Safety lock	<p>5 0 * This function is not activated. The appliance is not secured against unintentional switching on and programmes can be altered.</p> <p>5 1 This function is activated. The appliance is secured against unintentional switching on and programmes cannot be altered. See the relevant chapters in this booklet for instructions on how to activate these safety features.</p>



Altering oven settings

Oven setting		Settings available (* factory default)
<i>P 5</i>	Catalyser (depending on model)	<p><i>S 0</i> The catalyser is switched off, cooking odours are not dissipated.</p> <p><i>S 1</i> The catalyser is switched on for all cooking functions, cooking odours are dissipated.</p> <p><i>S 2 *</i> The catalyser is engaged for all functions except for Gentle bake.</p>
<i>P 6</i>	Rapid heat-up	<p><i>S 0</i> Rapid heat-up is switched off. The symbol  appears in the display.</p> <p><i>S 1 *</i> Rapid heat-up is switched on. The  symbol will appear in the display during Fan plus , Auto roast  and Conventional .</p>
<i>P 7</i>	Auto heat-up (applies to cookers with hobs only)	<p><i>S 0</i> The auto heat-up function is switched off. To bring to the boil you first have to select the maximum hob zone setting and once the food is boiling you must manually turn the power setting down.</p> <p><i>S 1 *</i> The auto heat-up function is switched on. When a hob zone setting is selected, the hob will start heating up on maximum power and then automatically reduce the power for continued cooking.</p>

Altering oven settings

Oven setting		Settings available (* factory default)
<i>P 8</i>	Fan run-on	<p><i>S 0</i> * The cooling fan run-on time is temperature controlled and will not switch off until the oven interior temperature is below 70 °C.</p> <p><i>S 1</i> The cooling fan run-on time is time controlled to switch off after 25 min.</p> <div style="border: 1px solid gray; padding: 10px; margin-top: 10px;"> <p>Do not leave food in the oven to keep it warm if you have set the cooling fan to timed operation. Moisture levels in the oven could increase, leading to condensation forming on the control panel and surrounding kitchen furniture and drops of moisture collecting under the worktop.</p> <p>Condensate can</p> <ul style="list-style-type: none"> – damage the housing unit / worktop. – lead to corrosion in the oven. </div>
<i>P 9</i>	Light	<p><i>S 0</i> The light switches itself off automatically after approx. 15 seconds.</p> <p><i>S 1</i> * The lighting will remain on.</p>
<i>P 10</i>	Factory default	<p><i>S 0</i> Standard factory default settings have been altered.</p> <p><i>S 1</i> * Factory default settings reinstated.</p>
<i>P 11</i>	Demo mode (for dealer showroom use only)	<p>---- * Demo mode not active. Four horizontal bars appear in the display.</p> <p><i>MES_</i> The oven is set to the showroom demo programme. If you turn the programme selector the word "<i>MES_</i>" will appear in the display briefly. The appliance can be operated but it will not heat up.</p>

We recommend the following settings for baking:

- Fan plus 
- Intensive bake 
- Conventional 

Bakeware

For the best baking results make sure that you chose bakeware in a **material** suitable for the particular oven function you choose.

Fan plus , Intensive bake

Most types of heat-resistant tins or dishes are suitable.

Conventional

The following baking tins give an even, brown result: Dark metal, aluminium or enamel tins with a matt finish. Heat resistant glass and ceramic dishes can also be used.

Avoid bright, shiny metal tins. These reflect heat, which means that the heat does not penetrate to the food effectively, resulting in uneven or poor browning.

In some cases the cakes might not cook properly. Place the tin or dish directly on the non-tip rack in the oven. Use one shelf level only.



Fan plus

Several shelf levels can be used at the same time for baking. The recommended positions are:

- 1 tray = 1st shelf level from the bottom
- 2 trays = 1st and 3rd shelf levels from the bottom
- 3 trays = 1st, 2nd and 4th shelf levels from the bottom

When baking moist biscuits, cakes or bread, do not bake on more than two levels.

Remember to remove the roasting filter from the back wall. Otherwise baking times will be longer and results uneven.

With Fan plus , the **baking temperature required is lower** than with Conventional . Refer to the baking chart and cookery book supplied with your oven.

Intensive bake

Remember to remove the roasting filter from the back wall. Otherwise baking times will be longer and results uneven.

Intensive bake is particularly useful for:

- dishes that require a moist topping and crisp base like pizza and quiche lorraine, or
- where the base has not been pre-baked.

Place the tin or dish on the baking tray on the **1st shelf level** from the bottom only. If the base is over-cooked use a higher shelf level next time.

Baking

Conventional

Only use dark baking tins with a matt finish. Bright, shiny tins will give an uneven or pale result, and in some cases the cakes might not cook properly.

Place tins centrally on the rack on **shelf level 1** or **2**.

Older recipes and cookery books

New guidelines (German standard DIN 44547 has been replaced by European standard EN 60350) have led to slight adjustments in oven temperature settings.

However, if using an older recipe or cookbook, set the oven temperature for Conventional 10 °C lower than that recommended.

The cooking duration does not need to be changed.

Tips on baking

Refer to the baking chart and the cookery book supplied with this oven for suggestions of temperatures, shelf levels and times.

With their anti-stick surface, PerfectClean baking trays and grill pans do not need to be greased or lined with baking parchment for baking. Baked goods are easily removed when done.

Baking parchment is only necessary when baking:

- Anything with a high salt content (e.g. pretzels, bread sticks), as the PerfectClean surface can be damaged by the sodium used in the dough;
- Meringues or biscuits with a high egg-white content, which are more likely to stick.

When baking cakes with **fresh fruit toppings** and **tall sponge cakes** place the tin in the grill pan to catch any spillages and keep the oven cleaner.

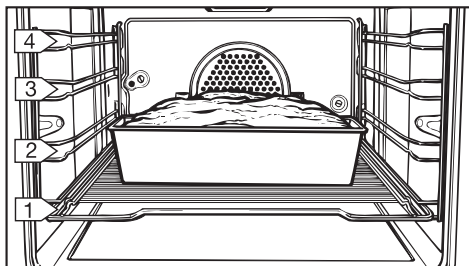

Place cakes in **rectangular tins** with the longer side across the width of the oven as shown, for optimum heat distribution and even results. Always use shelf level 1 for cakes in tins.

Frozen food

When baking frozen products such as **cakes, pizza and baguettes**, use the lowest temperature quoted on the manufacturer's packaging. Place such items on baking parchment directly on the rack or in the pizza pan (extra accessory). Placing them on the baking tray or in the grill pan can cause the metal to distort. This distortion would increase with subsequent use.

Small items of frozen food such as **oven chips or potato croquettes** can be cooked on a baking tray or in the grill pan. Place them on baking parchment and select the lowest temperature quoted on the manufacturer's packaging. Turn several times during cooking.

Handling and preparing food correctly is essential for maintaining good health.

Only bake cakes, pizza, chips etc. until they are golden brown. Do not overcook them.

To achieve even results without over-browning the food

- always select the **lowest temperature** given in the recipe/cooking instructions on the packaging. Do not set a temperature higher than that recommended. Increasing the temperature may reduce the cooking time, but will lead to uneven browning. In some cases food might not cook properly.
- Check if the food is cooked at the end of the **shortest time quoted**. To check if a cake is ready, insert a wooden skewer into the centre. It is ready if the skewer comes out clean, without dough or crumbs sticking to it.

The cooling fan will continue for a while after switching off the oven.

Always remove all accessories, trays and racks which are not being used, when using the oven, to keep the cleaning of trays etc. to a minimum.

Baking chart

	Fan plus		
	Temp. in °C	Recommended shelf level ⁵⁾	Time in mins.
Creamed mixture			
Sponge cake	150 - 170	1	50 - 70
Ring cake	150 - 170	1	65 - 80
Foam cake (tray) ¹⁾	150 - 170	1	25 - 30
Marble, nut cake (tin)	150 - 170	1	70 - 80
Fresh fruit cake, with filling (tray)	150 - 170	1	45 - 50
Fresh fruit cake (tray)	150 - 170	1	35 - 45
Fresh fruit cake (tin)	150 - 170	1	55 - 65
Flan base ^{1) 3)}	150 - 170	1	25 - 30
Small cakes ^{1) 3)} (tray)	150 - 170	1, 2, 4 ⁴⁾	20 - 25
Sponge mix ^{1) 3)}			
Sponge cake (3 to 6 eggs) ^{1) 3)}	160 - 180	1	25 - 35
Sponge cake (2 eggs) ^{1) 3)}	160 - 180	1	20 - 25
Swiss roll ^{1) 3)}	160 - 180	1	20 - 25
Rubbed in mixture			
Tart / flan base	150 - 170	1	20 - 25
Streusel cake	150 - 170	1	45 - 55
Small cakes ^{1) 3)} (tray)	150 - 170	1, 2, 4 ⁴⁾	15 - 25
Cheesecake	150 - 170	1	70 - 90
Apple pie ¹⁾	150 - 170	1	50 - 70
Apricot tart, with filling ¹⁾	150 - 170	1	55 - 75
Swiss apple pie ²⁾	190 - 210	1	25 - 35
Yeast mixtures and quark dough			
To prove dough	30 - 50	Oven floor ⁶⁾	15 - 30
Guglhupf	150 - 170	1	50 - 60
Streusel cake	150 - 170	1	35 - 45
Fresh fruit cake (tray)	160 - 180	1	40 - 50
White bread	160 - 180	1	40 - 50
Wholegrain bread ²⁾	170 - 190	1	50 - 60
Pizza (tray) ^{1) 3)}	170 - 190	1	40 - 50
Onion tart ¹⁾	170 - 190	1	25 - 35
Apple turnovers	150 - 170	1, 3 ⁴⁾	25 - 30
Choux pastry ^{1) 3)} , Eclairs	160 - 180	1, 3 ⁴⁾	30 - 40
Puff pastry ¹⁾	170 - 190	1, 3 ⁴⁾	20 - 25
Meringues ¹⁾ , Macaroons	120 - 140	1, 2, 4 ⁴⁾	25 - 50

Unless otherwise stated, the times given are for an oven which has not been pre-heated. With a pre-heated oven, shorten times by up to 10 minutes.

- 1) Pre-heat the oven when using Conventional.
- 2) Pre-heat the oven when using Fan plus and Conventional.
- 3) Do not use Rapid heat-up during the heating up phase.
- 4) Take baking trays out of the oven at different times if the food is sufficiently browned before the specified time has elapsed.
- 5) The shelf levels are counted from the bottom of the oven upwards (1 = lowest; 4 = highest)
- 6) Place the rack on the floor of the oven, and stand the bowl containing the dough on the rack.

Baking chart

Conventional			Intensive bake		
Temp. in °C	Recommended shelf level ⁵⁾	Time in mins.	Temp. in °C	Recommended shelf level ⁶⁾	Time in mins.
150 - 170	1	50 - 60	-	-	-
170 - 190	1	65 - 80	-	-	-
170 - 190	2	20 - 25	-	-	-
150 - 170	1	70 - 80	-	-	-
170 - 190	2	45 - 50	150 - 170	1	30 - 35
170 - 190	2	35 - 45	-	-	-
160 - 180	1	55 - 65	-	-	-
170 - 190	1	20 - 25	-	-	-
170 - 190	2	12 - 20	-	-	-
170 - 190	1	20 - 30	-	-	-
170 - 190	1	15 - 20	-	-	-
180 - 200	2	13 - 18	-	-	-
170 - 190	2	15 - 20	-	-	-
170 - 190	2	45 - 55	-	-	-
170 - 190	2	10 - 20	-	-	-
170 - 190	1	70 - 90	150 - 170	1	65 - 75
170 - 190	1	45 - 65	150 - 170	1	50 - 60
170 - 190	1	55 - 75	150 - 170	1	50 - 60
220 - 240	1	25 - 35	190 - 210	1	25 - 30
30 - 50	Oven floor ⁶⁾	15 - 30	-	-	-
160 - 180	1	50 - 60	-	-	-
170 - 190	2	35 - 45	-	-	-
180 - 200	2	40 - 50	-	-	-
180 - 200	1	40 - 50	-	-	-
190 - 210	2	50 - 60	-	-	-
190 - 210	1	30 - 40	170 - 190	1	40 - 50
180 - 200	1	25 - 35	170 - 190	1	25 - 35
160 - 180	2	25 - 30	-	-	-
180 - 200	2	25 - 35	-	-	-
190 - 210	2	15 - 25	-	-	-
120 - 140	2	25 - 50	-	-	-

The information given in this chart is intended only as a guide.

Roasting

We recommend using Auto roast  for roasting.

Conventional  can also be used.

When roasting on the rack or in an open tin make sure the roasting filter is fitted in front of the fan in the back of the oven before starting.

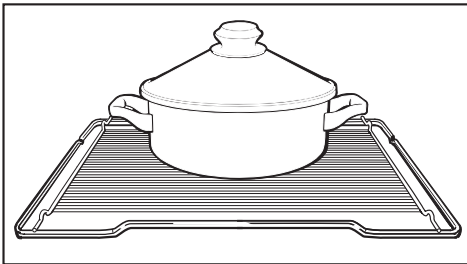

We recommend **roasting in a covered pot or using a roasting bag**, as

- this ensures that sufficient stock remains for making gravy.
- and the oven stays cleaner, too.

Roasting containers

Any heat-proof containers can be used: roasting pans with a lid, made from earthenware, cast iron, ovenproof china or glass, and roasting bags are all suitable.

Miele also offer Gourmet oven dishes with lids which are ideal for roasting and cooking larger quantities of food.

Place the roasting pan on the rack into a cold oven.

Exception:

Pre-heat at the temperature suggested when roasting beef.

Shelf levels

Use **shelf level 1** for roasting.

Exception:



With Conventional  use shelf runner 2 for

- poultry up to 1 kg,
- roast beef,
- and fish.

Temperature

Please refer to the **Roasting chart** for suggested **temperatures**.

Do not select a higher temperature than that advised. The meat will become brown, but will not be cooked properly.

With **Auto roast** , a temperature setting of 40 °C lower than for Conventional  is sufficient.

For **cuts which weigh 3 kg** or more, select a temperature approx. 10°C lower than that given in the roasting chart.

Roasting will take longer at the lower temperature, but will be more even.

For **roasting directly on the rack**, select a temperature that is about 20°C lower than for roasting in a covered pot.

When roasting on the rack, place the rack and anti-splash tray over the grill pan.

Older recipes and cookery books

New guidelines (German standard DIN 44547 has been replaced by European standard EN 60350) have led to slight adjustments in oven temperature settings.

However, if using an older recipe or cookbook, set the oven temperature for Conventional 10 °C lower than that recommended.

The cooking duration does not need to be changed.

Calculating the roasting time

The roasting time will depend on the type of meat, the size and thickness of the cut.

The traditional British method is to allow 15 to 20 minutes per lb/454 grammes, according to type of meat, plus approx. 20 minutes, adjusting the length of time as roasting proceeds to obtain the required result.

Tips on roasting

Browning only occurs towards the end of roasting time. Remove the lid about halfway through the roasting time if a more intensive browning result is desired.

After the roasting process is finished

take the roast out of the oven, wrap in aluminium foil and **leave to stand** for about 10 minutes.

This helps retain juices when the meat is carved.

Pot roasting

Season the meat and place in the pot. Add some knobs of butter or margarine or a little oil or cooking fat. Add about $\frac{1}{8}$ litre of water when roasting a large, lean joint of meat (2 - 3 kg) or roasting poultry with a high fat content.

Roasting on the rack

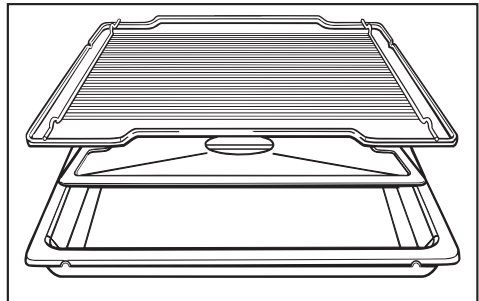

Place the anti-splash tray in the grill pan and then place the rack on top. Season the meat and place on the rack. Add a little fat or oil to very lean meat, or place a few strips of bacon on the top.

Roasting poultry

For a crisp finish, baste the poultry ten minutes before the end of cooking time with slightly salted water.

Frozen meat

Do not roast deep frozen meat. Meat should be thoroughly defrosted before roasting.

Roasting chart

Food	Recom- mended shelf level ⁶⁾	Auto roast ¹⁾		Conventional ^{1) 5)}	
		Temperature in °C ²⁾	Time in mins.	Temperature in °C ²⁾	Time in mins.
Roast beef (approx. 1 kg)	1	190 - 210	100 - 120	190 - 210	100 - 120
Beef fillet, approx. 1 kg ³⁾	1 ⁴⁾	190 - 210	45 - 55	200 - 220	45 - 55
Venison (approx. 1 kg)	1 ⁴⁾	180 - 200	90 - 120	190 - 210	90 - 120
Pork, joint (approx. 1 kg)	1	170 - 190	100 - 120	200 - 220	100 - 120
Pork, joint (approx. 2 kg)	1	170 - 190	120 - 150	180 - 200	120 - 150
Ham joint (approx. 1 kg)	1	170 - 190	70 - 80	200 - 220	60 - 70
Meat loaf (approx. 1 kg)	1	170 - 190	50 - 60	190 - 210	70 - 80
Veal (approx. 1.5 kg)	1 ⁴⁾	180 - 200	90 - 110	190 - 210	100 - 120
Leg of lamb (approx. 2.5 kg)	1	170 - 190	120 - 140	200 - 220	90 - 120
Rack of lamb, approx. 1.5 kg ³⁾	1	170 - 190	50 - 60	190 - 210	50 - 60
Poultry (0.8 - 1 kg)	1 ⁴⁾	170 - 190	50 - 60	190 - 210	60 - 70
Poultry (approx. 2 kg)	1	170 - 190	90 - 110	190 - 210	90 - 110
Poultry (approx. 2 kg)	1	170 - 190	120 - 150	190 - 210	110 - 130
Poultry (approx. 4 kg)	1	180 - 200	150 - 180	180 - 200	150 - 180
Whole fish (approx. 1.5 kg)	1 ⁴⁾	160 - 180	35 - 55	190 - 210	35 - 55

Unless otherwise stated, the times given are for an oven which has not been pre-heated.

- 1) Use the roasting filter.
- 2) Temperature in a covered pot
If open roasting, set the temperatures 20 °C lower.
- 3) Pre-heat the oven.
- 4) Use the 2nd shelf level from the bottom for Conventional.
- 5) We recommend using Auto roast for roasting, however Conventional can also be used.
- 6) The shelf levels are counted from the bottom of the oven upwards (1 = lowest; 4 = highest).

The information given in this chart is intended only as a guide.

Grill with the oven door closed.
If you grill with the door open, hot air will escape from the oven instead of being cooled automatically by the cooling fan. Oven controls could get hot. Danger of burning!

Always use the roasting filter when grilling.

Grill settings

Grill

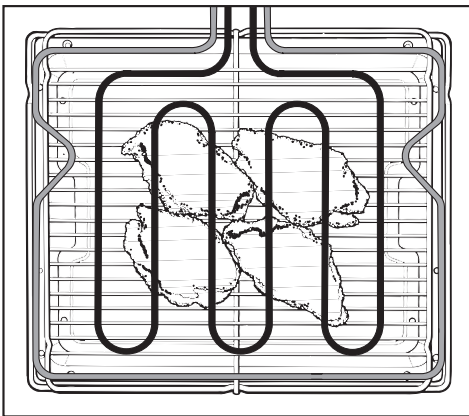

For grilling thin cuts and for browning food. The inner part of the upper heating element gets hot.

Grill - full

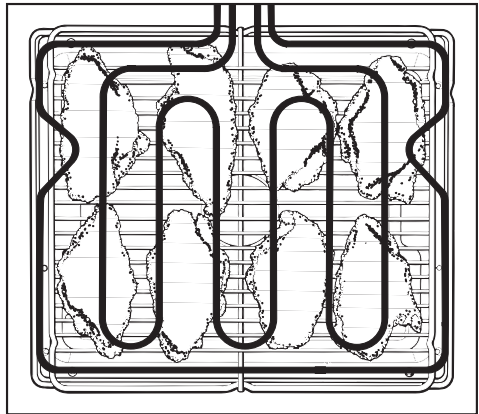

For grilling large quantities of thin cuts and for browning food in large dishes. The whole of the grill element gets hot.

Fan grill

For grilling larger items, e.g. rolled meat, poultry.

Always use the roasting filter when grilling.

Preparing food for grilling

Clean, wipe dry and season with pepper and herbs. Do not season meat with salt before grilling as this draws the juices out.

Add a little oil if necessary. Do not use other types of fat as they can get too dark, burn and cause smoke.

Clean fish in the normal way. To enhance the taste, add a little salt or squeeze a little lemon juice over the fish.

Grilling

Grilling on the rack

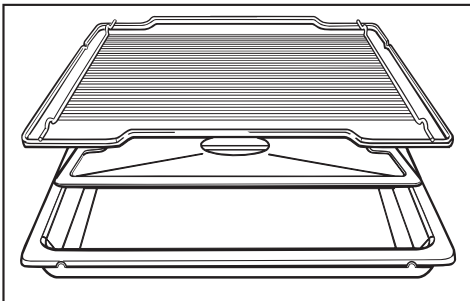

- Assemble the rack on the grill pan and use the anti-splash tray as illustrated.
- Place the food on the rack.
- Select the grill setting.
- Set a temperature.
- Pre-heat the grill for at least 5 minutes with the door shut before grilling.
- Place the grill pan under the grill and shut the door.
For thin cuts use shelf level 3 or 4
For thicker cuts use shelf level 1 or 2
- Most items should be turned half way through cooking.

Temperature

For thin cuts of meat
(e. g. chops or steak) 275 °C

For grilling larger items,
(e. g. rolled meat, poultry) 240 °C

See the grill chart for more information.

To grill thicker pieces of food more gradually after an initial high

temperature, continue grilling at a lower temperature setting to allow the food to cook through to the centre.

Grilling times

- Flat pieces of fish and meat usually need 6 – 8 minutes per side depending on their texture.
- Thicker pieces take a little longer.
- With rolled meats allow approx. 10 minutes per cm diameter.

Tips on grilling

It is best to grill food of a similar thickness at the same time so that the grilling time for each item does not vary too greatly.

One way of finding out how far through a piece of meat has been cooked is to press down on it with a spoon:

- If there is very little resistance to the pressure of the spoon, it is still red on the inside ("rare").
- If there is some resistance the inside will be pink ("medium").
- If there is great resistance, it is thoroughly cooked through ("well done").

Grill chart

Pre-heat the grill for at least 5 minutes with the door shut before grilling.

Food to be grilled	Recommended shelf level ⁴⁾	Grill / Grill - full ¹⁾		Fan grill ¹⁾	
		Temp. in °C	Total grilling time in mins. ²⁾	Temp. in °C	Total grilling time in mins. ²⁾
Thin cuts					
Steaks	3 or 4 ³⁾	275	10 – 16	220	10 – 16
Kebabs	3	240	25 – 30	220	25 – 30
Chicken kebabs	3	240	20 – 25	200 – 220	20 – 25
Cutlets/schnitzel	3 or 4 ³⁾	275	12 – 18	220	18 – 20
Liver	3 or 4 ³⁾	275	8 – 12	220	10 – 14
Burgers	3 or 4 ³⁾	275	14 – 20	220	16 – 20
Sausages	3 or 4 ³⁾	275	10 – 15	220	8 – 12
Fish fillet	3 or 4 ³⁾	275	12 – 16	220	12 – 16
Trout	3 or 4 ³⁾	275	16 – 20	220	20 – 25
Toast	3 or 4 ³⁾	275	2 – 4	220	3 – 5
Cheese toast	3 or 4 ³⁾	275	7 – 9	220	4 – 6
Tomatoes	3 or 4 ³⁾	275	6 – 8	220	6 – 8
Peaches	3	275	6 – 8	220	7 – 10
Thicker cuts					
Chicken (approx. 1 kg)	2	-	-	200 – 220	50 – 60
Rolled meat, Ø 7 cm, (approx. 1 kg)	1	-	-	200	75 – 85
Piece of pork (approx. 1 kg)	1	-	-	200	100 – 120
Sirloin, (approx. 1 kg)	1 ³⁾	-	-	250	25 – 35

1) Use the roasting filter when grilling.

2) Turn half way through the grilling time.

3) Select the appropriate shelf level for the thickness of the food.

4) The shelf levels are counted from the bottom of the oven upwards (1 = lowest; 4 = highest)

The information given in this chart is intended only as a guide.

Defrosting

You can also use the oven for defrosting.

To defrost select **Fan plus**  with a **maximum temperature of 50 °C**.

For defrosting meat and delicate foods, use the lowest possible temperature (30 °C).

Please note:

- Where possible remove the packaging and put the food to be defrosted on a baking tray or into a dish.
- All meat and poultry should be fully defrosted before cooking. Do not use the liquids from defrosting.
- When defrosting poultry, put it on the rack over the grill pan to catch the defrosted liquid so that the meat is not lying in this liquid.

It is particularly important to observe food hygiene rules when defrosting poultry. Do not use the liquid from the defrosted poultry. Pour it away, and wash the tray, the sink and your hands. Danger of salmonella.

- Fish does not need to be fully defrosted before cooking. Defrost so that the surface is sufficiently soft to take herbs and seasoning.

Do not refreeze food once it has thawed.

We recommend using the following oven settings:

- Fan plus
- Conventional

Cooking containers made of ovenproof glass, porcelain, china, and earthenware are all suitable. They should have heat-resistant handles and knobs. Roasting bags can also be used.

- Put the rack in on **shelf level 1** and place the dish on the rack.
- Select the **cooking function** you want and set a **temperature**.

Fan plus 170 – 190 °C
 Conventional 180 – 200 °C

Cooking durations

Casseroles 70 – 90 mins.
 Gratins/bakes 40 – 60 mins.

Tips

Cover dishes which are to be cooked in their own juice and/or steam, e.g. potatoes or vegetables, so that they do not dry out. If you do not have a lid, use aluminium foil or damp cooking parchment.

Cook without a lid when a crusty finish or topping is required, e.g. for meat or au gratin dishes.

You can also **stack one dish on top of another**. Invert the lid of the bottom pot and place the top pot on it. Put food which needs to be browned in the top dish.

Gentle bake

The Gentle bake function is ideal for gratins and bakes which require a crispy finish.

Use the first shelf level from the bottom.

Food	Temp. in °C	Time in mins.
Lasagne	200	45 – 60
Potato gratin	190	55 – 65
Vegetable bake	190	55 – 65
Pasta bake	190	40 – 50

The table contains just a few examples. For other recipes, use the temperature and time settings given for Conventional as a guide.

Cleaning and care

In the UK, Miele branded cleaning and conditioning products as well as a microfibre E-cloth, which is suitable for cleaning surfaces such as stainless steel, glass, plastic and chrome without the use of chemicals, are available from the Miele Spare Parts Dept. or via the Internet (depending on country).

Appliance front and control panel

Clean the

- controls,
- door handle,
- trim inside the door

regularly, preferably after each use.

This will help to prevent grease and other deposits adhering to the surfaces and becoming difficult to remove and also in some cases, causing discolouration.

- All surfaces and controls should be cleaned using a Miele E-Cloth or with warm water and a little washing up liquid applied with a soft sponge or cloth.
- Wipe the surfaces dry using a soft cloth.

Do not use scouring agents, hard sponges or brushes or sharp metal tools to clean glass as these can scratch the surface.

To prevent the risk of scratches and damage to the surface structure of glass, stainless steel and aluminium fronted appliances, pay particular attention to the following cleaning instructions.

Glass fronted appliances

The appliance front and controls are susceptible to scratches and abrasion.

Avoid:

- abrasive cleaning agents, e.g. powder cleaners and cream cleaners,
- abrasive sponges, e.g. pot scourers or sponges which have been previously used with abrasive cleaning agents,
- sharp metal tools,
- oven sprays.

Aluminium fronted appliances

Aluminium is affected by the way that light falls on it, by the surrounding environment and by the angle you observe it from.

Aluminium surfaces and controls may suffer discolouration or damage if soiling, acids or alkaline substances are left on them for too long.
Remove these straight away.

The appliance front and controls are susceptible to scratches and abrasions.

Avoid:

- cleaning agents containing soda, acids or chlorides,
- abrasive cleaning agents, e.g. powder cleaners and cream cleaners,
- abrasive sponges, e.g. pot scourers or sponges which have been previously used with abrasive cleaning agents,
- stainless steel cleaning agents,
- cleaning agents containing descaling agents,
- dishwasher cleaner,
- oven sprays.

Stainless steel fronted appliances

The appliance front and controls are susceptible to scratches and abrasion.

Please observe the cleaning instructions for

- stainless steel surfaces,
- stainless steel coloured controls.

Stainless steel surfaces

Stainless steel surfaces can be cleaned using a Miele E-Cloth or with a proprietary non-abrasive cleaning agent designed specifically for use on stainless steel. N.B. Do not use stainless steel cleaning agents on the controls.

Avoid:

- cleaning agents containing soda, acids or chlorides,
- abrasive cleaning agents, e.g. powder cleaners and cream cleaners,
- abrasive sponges, e.g. pot scourers or sponges which have been previously used with abrasive cleaning agents.

To help prevent re-soiling, a conditioning agent for stainless steel can also be used. Follow the manufacturer's instructions on the label.

Cleaning and care

Stainless steel coloured controls

The controls may suffer discolouration or damage if soiling is left on them for too long. Remove soiling straight away.

Avoid:

- cleaning agents containing soda, acids or chlorides,
- abrasive cleaning agents, e.g. powder cleaners and cream cleaners,
- abrasive sponges, e.g. pot scourers or sponges which have been previously used with abrasive cleaning agents,
- stainless steel cleaning agents,
- oven sprays.

If you are unsure about a particular product or need further advice, please contact your nearest Miele Sales office. See back page for details.

Accessories

Remove all accessories as well as the runners and any extra accessories such as, for example, the baking carriage, or telescopic runners from the oven interior before starting the pyrolytic cleaning process. The high temperatures needed for pyrolysis will damage the accessories and cause irreparable damage to the baking carriage and telescopic runners.

Baking tray, grill pan, anti-splash tray (if fitted), racks and runners

The surfaces of these have been treated with **PerfectClean enamel**.

Please refer to the section "PerfectClean" for information on cleaning and care.

Roasting filter

Clean in a solution of hot water and a little washing-up liquid or in the dishwasher.

If cleaned in the dishwasher, results are better if the filter is placed horizontally in the basket.

Some dishwasher detergents may cause the surface of the metal filter to discolour. This discolouration will not affect the functioning of the filter in any way.

The roasting filter, unlike other accessories, can be pyrolytically cleaned. Although this may cause permanent discolouration, it will not affect the functioning of the filter in any way.

PerfectClean

Before using for the first time remove any stickers from PerfectClean surfaces.

The enamelled surfaces of the baking tray, grill pan, anti-splash tray (if fitted), rack and runners have been treated with a special type of enamelling called "**PerfectClean**".

This surface has very good anti-stick properties which is much easier to keep clean than conventional oven enamel, if cleaned regularly.

Food can be taken off it more easily and soiling from baking and roasting is easier to remove.

The following notes on cleaning and care should ensure that the anti-stick and easy clean properties of PerfectClean last for many years.

PerfectClean surfaces can be treated as you would treat glass. If you are unsure whether a particular cleaning product is suitable for PerfectClean consider whether you could clean a window pane with the product without damaging it.

Food can be sliced or cut up on the PerfectClean surface in the same way as on a baking tray with conventional enamel.

Allow the oven and any accessories to cool down before cleaning.
Danger of burning!

Normal soiling

Clean as soon as possible after each use with a dishcloth, soft sponge or a soft nylon brush, and a solution of hot water and a little washing-up liquid. The longer soiling is left the harder it may become to remove.

Stubborn soiling

Stubborn soiling e.g. from roasting may need to be soaked first with a damp sponge to loosen it and if necessary a non-abrasive stainless steel spiral pad or a scraper suitable for glass surfaces can be used to remove it.

After cleaning rinse thoroughly with clean water. The water must run off the surface easily. Any residual cleaning agents will hinder this effect.

Using oven sprays on very stubborn soiling

Some oven cleaners contain strong alkalines and / or abrasive materials. Because the enamel is designed to be easily cleaned the use of these cleaners is not recommended. However if you still cannot get the surface clean, an oven cleaner can be used for a couple of minutes only. Do not attempt to use on a hot oven or accessories. Allow the PerfectClean surfaces to cool down to room temperature before applying oven sprays!

Cleaning and care

Apply a spray oven cleaner to the soiled areas. Leave to take effect for **a couple of minutes only!**

If necessary use a soft sponge, soft nylon brush or a scraper suitable for glass surfaces to loosen the soiling.

Repeat the process if necessary.

After cleaning rinse thoroughly with clean water and then dry thoroughly.

Important

For optimum performance of the PerfectClean enamel it is important to clean the oven and accessories after each use.

The surfaces will become harder to clean and the anti-stick properties will deteriorate if soiling is not removed after each use and allowed to build-up. In extreme cases cleaning may even become impossible.

The following cause lasting damage to the surface structure and reduce the anti-stick effect and must not be used on PerfectClean surfaces:

- abrasive cleaning agents
- wire wool or metal scourers
- pot scourers
- oven cleaning pads
- sponges and cloths which have previously been used with abrasive cleaning agents.
- oven spray must not be used in a hot oven or left on for too long.
- items coated with PerfectClean enamelling must not be cleaned in a dishwasher.

Note

Soiling such as spilt juices and cake mixtures are best removed whilst the oven or tray is still warm. Exercise caution, make sure the oven is not hot - danger of burning!

Spilt fruit juices may cause lasting discolouration of the surfaces and roasting can cause matt areas to appear. Clean these following the instructions given above and do not try and use force to remove them! This discolouration is permanent but will not affect the efficiency of the enamel.

When baking items with a high salt content (e.g. continental pretzels) place them on baking parchment in the baking tray or grill pan. Sodium deposits can cause lasting discolouration to PerfectClean surfaces.

Oven interior

The oven interior and roof liner are coated with dark **pyrolytic enamel** which facilitates cleaning.

This is a particularly hard enamel with an extremely smooth surface. Because of its anti-stick properties most debris can be easily removed with warm water and a little washing-up liquid applied with a soft cloth. This should be done after each use.

Allow the oven to cool down before cleaning.

Danger of burning!

Never use hard brushes, hard sponges, wire wool pads*, knives or any other abrasive materials or cleaning agents. They can damage the enamel.

If using an oven spray, the manufacturer's instructions must be followed.

* Non-abrasive stainless steel spiral pads can be used

Pyrolytic cleaning of the oven interior

Before starting a pyrolytic cleaning process please note the following advice:

Remove any coarse soiling from the oven before you start.

Clean the interior glass door panel thoroughly. Otherwise, splashes on the door may burn on making them difficult to remove.

There is a fibre-glass door seal around the oven cavity.

This seal is particularly sensitive and should not be cleaned unless absolutely necessary. Rubbing the seal can damage it.

Remove all accessories as well as the runners and any extra accessories such as, for example, the baking carriage, or telescopic runners from the oven interior before starting the pyrolytic cleaning process. The high temperatures needed for pyrolysis will damage the accessories and cause irreparable damage to the baking carriage and telescopic runners.

The oven door gets much hotter during pyrolytic operation than during normal use.

Make sure children cannot touch the oven whilst a pyrolytic programme is running. Danger of burning.

Cleaning and care

During the pyrolytic process the oven is heated to approx. 460 °C . Any residual soiling is burnt off by the high temperatures.

The oven door is automatically locked shortly after the pyrolytic cleaning process starts.

Depending on soiling levels you can choose between three cleaning programmes:

- *PY 1* lasting approx. 2 hours 15 mins
- *PY 2* lasting approx. 2 hours 35 mins
- *PY 3* lasting approx. 2 hours 55 mins

The door cannot be opened until this duration has been completed.

You can delay the start of the pyrolytic process for example, to take advantage of cheaper night electricity tariffs.

Starting a pyrolytic process

- Take all accessories out of the oven.
- Turn the function selector to the pyrolytic  programme position.



PY 1 will appear in the display. The digit will start flashing.

- Turn the multi-function selector until the required pyrolytic programme digit shows in the display.
- Press the multi-function selector gently.

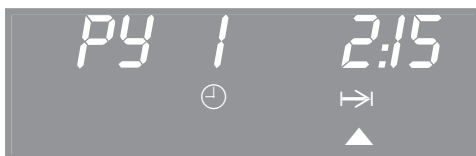

The digit for the pyrolytic programme selected together with its duration will show in the display.

The appliance door will lock and the heating elements will begin to heat up.



The pyrolytic programme duration can be followed counting down in the display.

You can **set a delay time for the pyrolytic process to start at** during the first five minutes after starting the programme, for example, to take advantage of cheaper night electricity tariffs. To do so:

- Call up the  symbol and select a start time.

You can change the start time if you wish at any time up until the delay period has elapsed.

At the end of pyrolytic cleaning process

- the  symbol will start flashing.
- an audible tone sounds five times, if it is switched on (see section "Altering oven settings  – P 2").

- Turn the programme selector to "0".

The buzzer will stop and the symbols in the display will go out.

After the pyrolytic process any debris (e.g, ash), can easily be wiped away.

Remember to wait until the oven has cooled down before doing so!
Danger of burning!

Try not to wipe over the fibre-glass seal when cleaning the oven cavity. It is particularly sensitive and should not be cleaned unless absolutely necessary. Rubbing it can damage it.

Most residues are easily wiped away with a damp cloth.

Depending on soiling levels in the oven there may be visible deposits on the door and below the trim under the oven cavity. This is best removed using a non-abrasive sponge or non-abrasive stainless steel spiral pad and a mild solution of warm water and washing-up liquid.

Deposits on the internal door panel can be removed using a suitable glass scraper.

Spilt fruit juices may cause lasting discolouration to the surfaces. This discolouration is permanent but will not affect the efficiency of the enamel. Do not attempt to remove these marks.

To make cleaning easier you can

- remove the **oven door**,
- take out the **runners**.

Instructions for doing so are given further on in this chapter.

The **pyrolytic process will be interrupted**,

- if the soiling levels in the oven are too much for the programme to deal with.

The message "**F 23**" will appear in the display.

Remove all coarse soiling before starting the pyrolytic process again.

- if the programme selector is turned to "0".
- if another function is selected during the pyrolytic process.
- in the event of a power cut.

Turn the programme selector to "0". If the oven interior temperature is below 280 °C, the door lock will be released after a period of approx. 30 s. It can then be opened. Start the pyrolytic cleaning process again if necessary.

Cleaning and care

To remove the oven door

Please note: the oven door is heavy and should be gripped firmly at both sides when being removed or refitted.

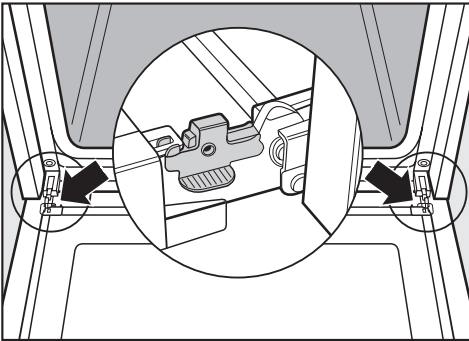

The oven door is connected to the oven by hinges.

Before removing the door, the locking clamps on both hinges have to be released.

- Open the door fully.

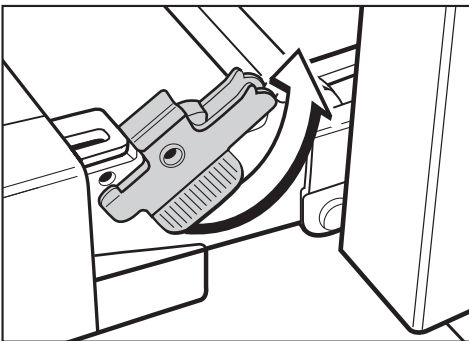

- To release the locking clamps on the hinges turn them upwards as far as they will go until they are at an angle. See illustration.

- Then lift the door upwards as far as it will go.

Do not attempt to take the door off the hinge guides when it is in a horizontal position. The guides will close, and damage the appliance. Danger of injury.



- Hold the door securely at both sides and lift upwards off the hinge guides.

Do not lift the door off by the handle. The handle could break and damage the glass.

Make sure that you lift the door off equally on both sides.

To dismantle the oven door

In the rare event that condensate has worked its way in between the glass panes, the door can be dismantled in order to clean in between the panes.

Do not use scouring agents, hard sponges or brushes or sharp metal tools to clean glass as these can scratch the surface.

Do not use an oven spray. This would damage the surface of the aluminium surrounds.

- Always remove the oven door before dismantling it.
- Place the door on a protective surface (e.g. on a towel) to protect it from breakage and to prevent it getting scratched.
The door handle should line up with the edge of the table. Make sure the glass lies flat to protect it from damage during cleaning.

The oven door is made up of a total of four panes of glass.

Spacers are located next to the hinge guides which keep the individual door panes in position.

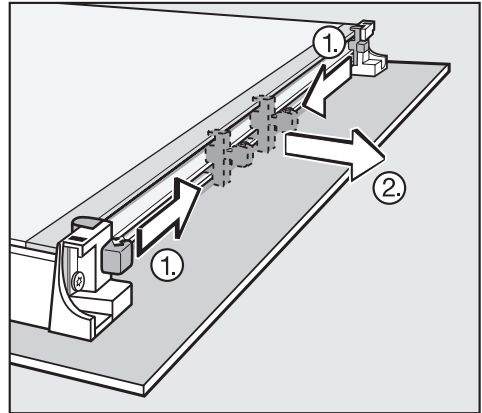

- Push the spacers towards the centre of the door and then pull them off. If they are difficult to remove lift the middle pane up a little. The spacers should then be easier to move.

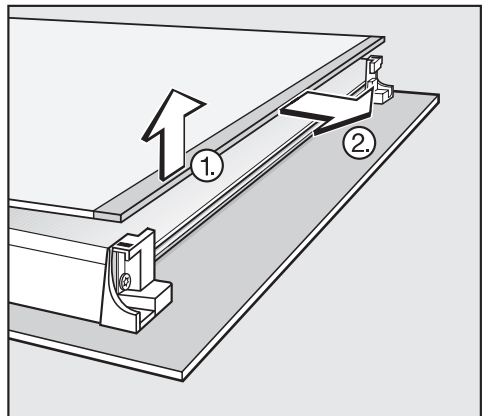

- **Carefully** lift the inner pane up and out.

Cleaning and care

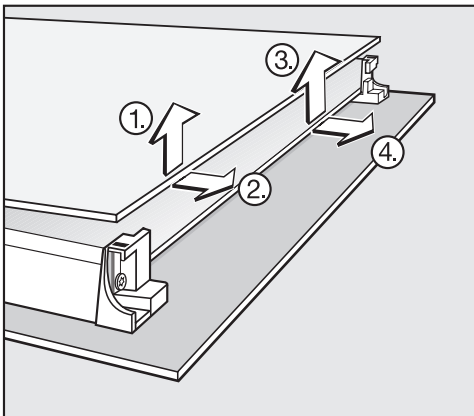

■ Then **carefully lift the middle panes up and out.**

- The individual panes can then be cleaned.
Handle them very carefully to avoid the risk of breakage.

When putting the door back together again replace the middle panes first. These panes are identical and both have a corner missing. When replacing the first pane this cut-off corner should be on the right hand side, and when replacing the second pane it should be on the left.

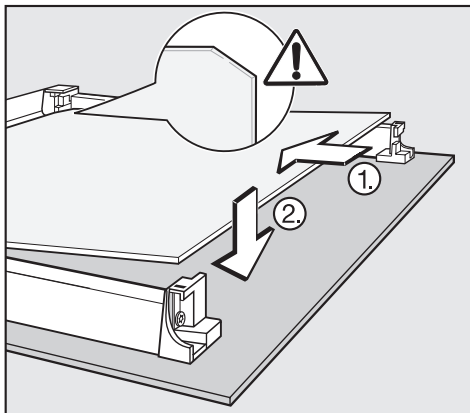

- Replace the first of the middle panes. Make sure the cut-off corner is positioned at the **top right hand side.**

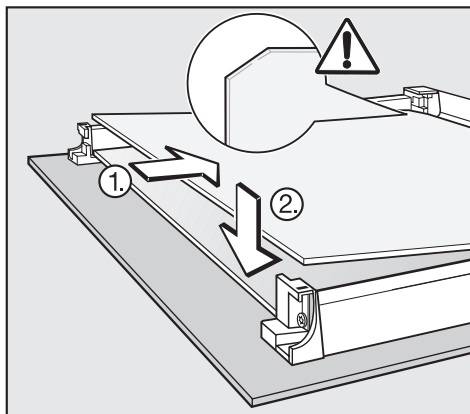

- Replace the second of the middle panes. Make sure the cut-off corner is positioned at the **top left hand side.**

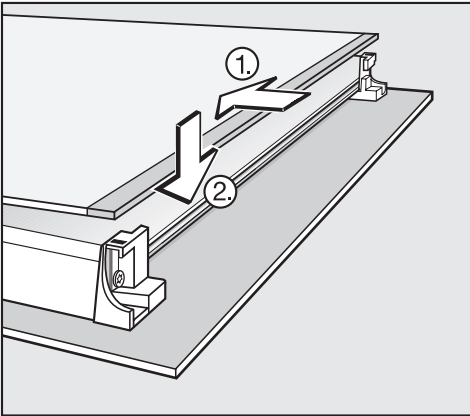

- Finally replace the black printed inner pane. The print should face the middle pane.

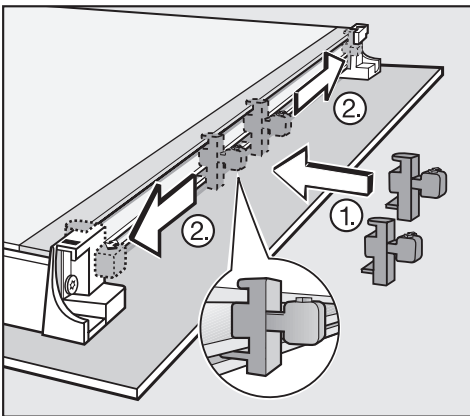

- Lift the upper of the two middle panes up a little and refit the spacers to the panes. Then re-position them back next to the hinge guides.

Before putting the door back on to the oven make sure that the inner pane is sitting correctly in its retainers and that it cannot come loose and get damaged by mistake.

To refit the door

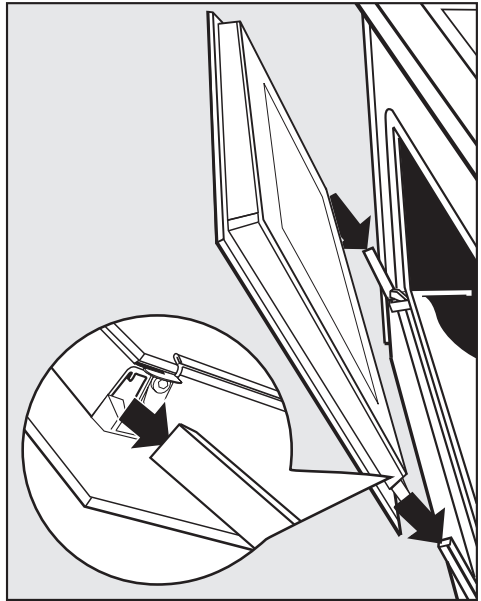

- Hold the door securely at both sides and carefully fit it back onto the hinge guides.

Make sure that the door goes back on straight.

Cleaning and care

- Open the door fully.

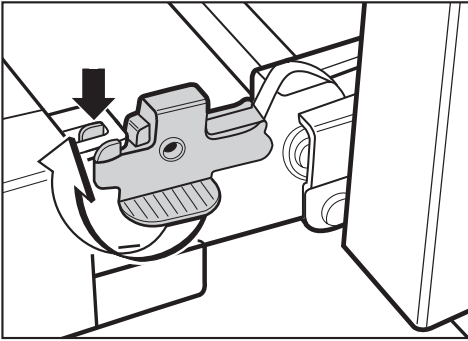

- Flip both locking clamps back up to lock them. Turn them as far as they will go into a horizontal position. Make sure that the notches on the locking clamps hook into the slots on the door as illustrated.

It is essential that the locking clamps lock securely when the door is re-fitted after cleaning. Otherwise the door could work loose from the hinges, resulting in damage to the door.

To remove the runners

Make sure the oven heating elements are switched off and cool. Danger of burning.

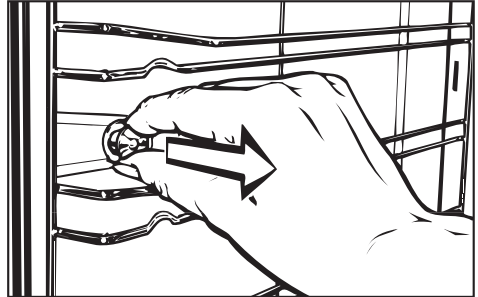

- Pull on the fixing knob to release it.

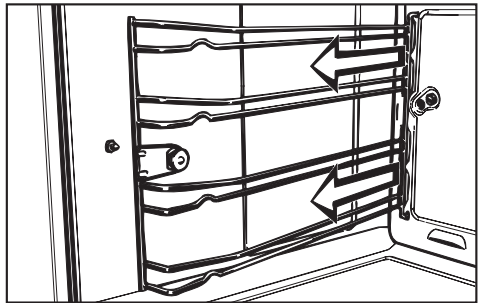

- Remove the runners.

Reassemble in the reverse order, carefully ensuring all parts are correctly in place.

Installation, maintenance and repairs may only be carried out by suitably qualified and competent persons in accordance with local and national safety regulations.

Repairs and other work by unqualified persons could be dangerous, and the manufacturer will not be held liable for unauthorised work.



Ensure current is not supplied to the appliance until after maintenance or repair work has been carried out.

Some minor problems can be corrected without contacting the Miele Service Department.

What to do if . . .

. . . the oven does not heat up

Check whether,

- the system lock has been activated.
- the mains fuse has tripped. Contact a qualified electrician or the Service Department.
- "MES_" appears briefly in the display when the programme selector is turned to the light /  position.

The oven is set to the showroom demo programme. In this setting you can select a programme as normal but the oven will not heat up.

You will need to deactivate demo mode, see "Altering oven settings  – P II".

. . . the heating works, but not the oven lighting.

The halogen lamp needs replacing.

To change the lamp:

- Disconnect the appliance from the electricity supply.
Switch off and unplug at the socket, or remove the fuse, or switch off at the isolator as appropriate.
- Remove the runners.
- Cover the floor of the oven with a towel to protect the enamelling just in case the lamp cover is dropped.

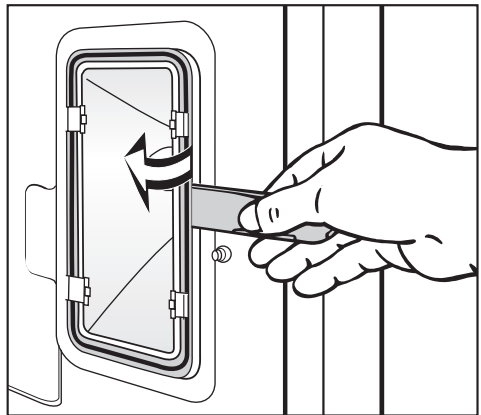

- Use the lever to release the lamp cover from its frame.

Problem solving guide

The glass cover is held in position by two metal brackets which are secured to the reflector.

Do not push the metal brackets to the sides, as this would damage both the brackets and the reflector. It might also make it difficult to push the glass cover back into its frame again.

Do not touch the surface directly when changing the lamp as grease particles from your fingers will adhere to the surface and damage the lamp. Please follow the manufacturer's instructions.

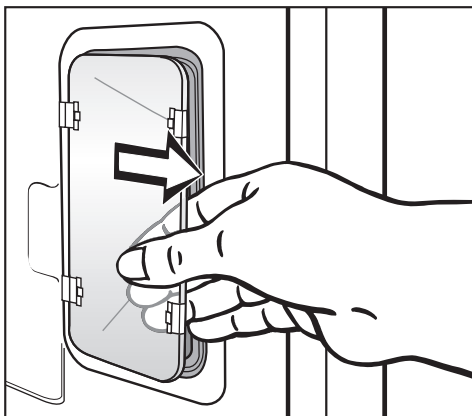

- Pull the glass cover out of the rear metal brackets.
- Pull the defective halogen lamp out. When purchasing a new lamp it is a good idea to take the old one with you to make sure you get the correct replacement (12 V, 20 W, heat resistant to 300 °C, G4 fitting, Osram, Type 64428).

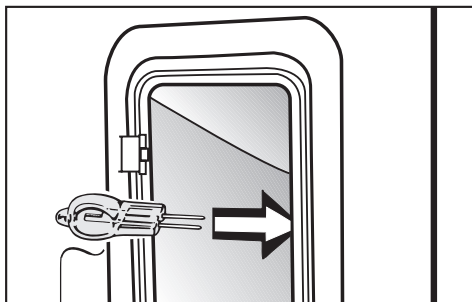

- Replace it with a new one, making sure it goes into its socket horizontally.

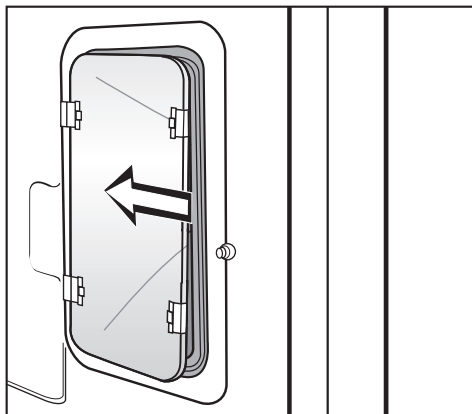

- Push the glass cover back into the metal clamps with the cut out edge towards the rear.

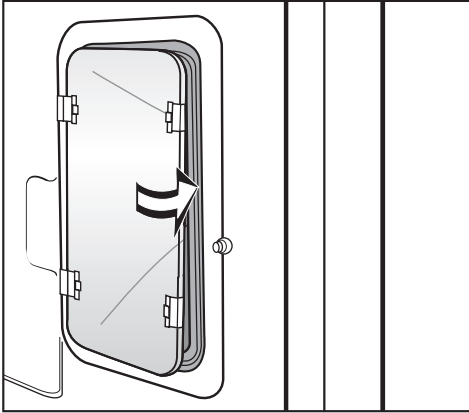

- Push the glass cover into its frame at the front.
- Replace the runners (and side liners if fitted).

Reassemble in the reverse order, carefully ensuring all parts are correctly in place.

... no noise is heard when the oven door is opened during operation.



This is not a fault.
If the door is opened during operation, the door contact switch causes the oven heating, and the fan, depending on which oven function has been chosen, to be switched off.

... a noise can be heard after a cooking process

This is not a fault.
The cooling fan continues to run for a while after the oven has been switched off to prevent any humidity building up in the oven, on the control panel or on the oven housing unit. When the temperature has fallen sufficiently, the fan switches off automatically. The temperature will fall faster with the oven door open.

... cakes and biscuits are not cooked properly after following the times given in the chart

Check whether,

- the correct temperature was set.
- there has been a change to the recipe. The addition of more liquid or more eggs makes a moister mix which would need longer to cook.
- the roasting filter was left in front of the fan when baking with Fan plus  or Intensive bake . If this was the case, baking times might need to be lengthened by approx. 10 to 15 minutes.

Problem solving guide

... cakes or biscuits are unevenly browned

There will always be a slight unevenness.

If browning is very uneven, check

when baking with **Fan plus** :

- whether the temperature was set too high,
- whether the roasting filter was in place,
- whether the correct shelf level was used.

when baking with **Conventional** :

- the colour and material of the baking tins being used. Light coloured, shiny, or thin walled tins are less suitable,
- whether the correct shelf level was used.

... there has been a power cut and the time of day is flashing in the display.

All pre-set times have been deleted because of the power cut.

You will have to enter the cooking processes again.

... "F" and a number appear in the oven display

This combination indicates a fault.

- "**F 23**": The pyrolytic temperature of approx. 460 °C was not reached. This could have been caused by too much soiling in the oven to start with. Remove all coarse soiling before starting the pyrolytic cleaning programme again.
If the fault message appears again

please contact the Miele Service Department.

- "**F 32**": The door has not locked. Interrupt the pyrolytic cleaning programme by turning the programme selector to "0". Then start it up again.
If the fault code appears again call the Miele Service Department.
- "**F 33**": The door lock for the pyrolytic cleaning programme will not open. Interrupt the pyrolytic cleaning programme and turn the programme selector to "0". If the door lock will still not open please contact the Miele Service Department.
- "**F 55**": the oven has automatically switched itself off during use. This is a safety feature to protect the oven if it has been operating for an exceedingly long period. The length of time depends on the oven function selected.

The oven can be used again immediately by simply turning the programme selector to "0" and entering the process again.

For **all other fault codes** please contact the Miele Service Department.

In the event of any faults which you cannot remedy yourself, please contact

– your Miele Dealer

or

– the Miele Service Department
(see back cover for contact details).

When contacting your Dealer or the Service Department, please quote the model and serial number of your appliance.

These are shown on the data plate, visible below the oven interior, with the door fully open.

Please note that telephone calls may be monitored and recorded for training purposes.

Extra accessories

The following accessories may come standard with some models. They following accessories are available at extra cost from your Miele Dealer, the Miele Spare Parts Department or via the Internet (depending on country).

Telescopic baking carriage

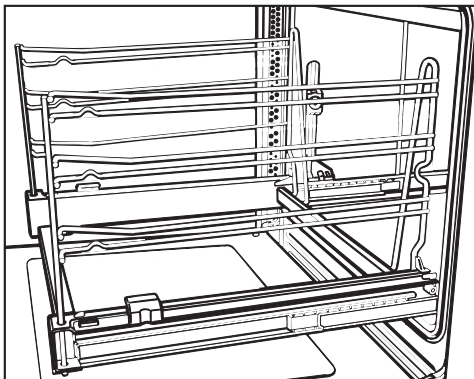

The telescopic baking carriage has four shelf levels and can be drawn right out of the oven, giving a good overview of cooking in progress.

Do not leave the baking carriage in the oven during the pyrolytic cleaning process. The high temperatures needed for pyrolysis will burn the lubricant in the runners and cause irreparable damage to the baking carriage.

Telescopic runners

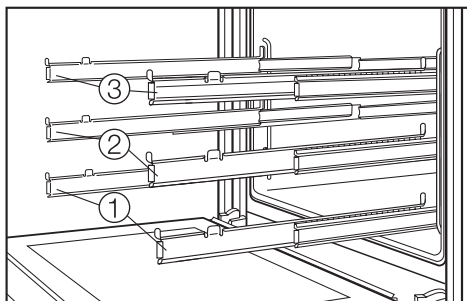

The telescopic runners provide three shelf levels. Each shelf level can be drawn right out of the oven individually to give a good overview of cooking in progress.

Do not leave the telescopic runners in the oven during the pyrolytic cleaning process. The high temperatures needed for pyrolysis will burn the lubricant in the runners and cause irreparable damage.

Pizza pan

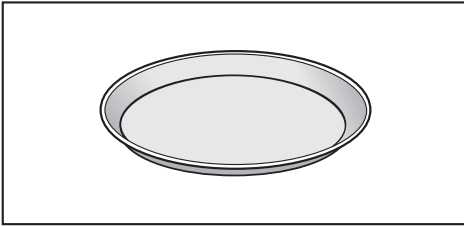

This circular pan is suitable for cooking pizzas, flat cakes made with yeast or whisked mixtures, sweet and savoury tarts, baked desserts, and can also be used for deep frozen cakes and pizzas.

Baking stone

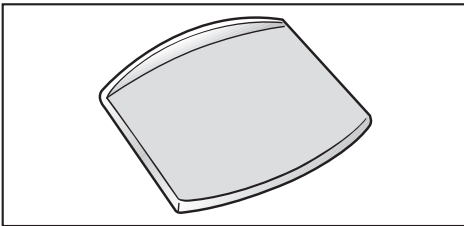

The baking stone is ideal for items which need a well baked base such as pizza, quiche, bread, bread rolls and savoury snacks.

The baking stone is made from heat retaining fire brick and is glazed. Place it directly on the rack.

A paddle made of untreated wood is supplied with it for placing food on the baking stone and taking it off.

Gourmet oven dish

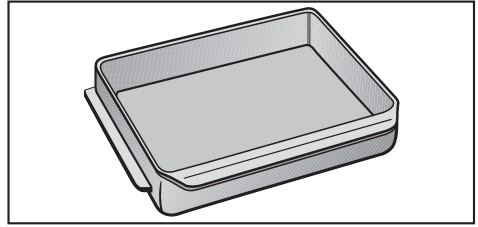

The gourmet oven dish can be placed in the oven directly on the runners. It has non-tip safety notches like the oven tray to prevent it being pulled out too far.

The dish has a special protective anti-stick coating.

It is available in two sizes:

HUB 61-22, 8 - 10 servings,
W x D x H: 38 x 22 x 8.6 cm

HUB 61-35, 16 - 20 servings,
W x D x H: 38 x 35 x 8.6 cm

A lid is available separately.

Electrical connection UK, IRL, ZA

All electrical work should be undertaken by a suitably qualified and competent person in strict accordance with current national and local safety regulations (BS 7671 in the UK).

Installation, repairs and other work by unqualified persons could be dangerous. The manufacturer cannot be held liable for unauthorised work.

Ensure power is not supplied to the appliance until after installation or repair work has been carried out.

The **voltage and connected load** are given on the data plate, visible below the oven interior, with the oven door open. Ensure that these match the household mains supply. Please quote these data, and the model and serial number when contacting the Miele Service dept.

Connection of this appliance should be made via a suitable isolator, which complies with national and local safety regulations, and the on/off switch should be easily accessible after the appliance has been built in.

If the switch is not accessible after installation (depending on country) an additional means of disconnection must be provided for all poles.

For extra safety it is advisable to install a residual current device with a trip current of 30 mA (in accordance with DIN VDE 0664, VDE 0100 Section 739).

When switched off there must be an all-pole contact gap of 3 mm in the

isolator switch (including switch, fuses and relays acc. to EN 60 335).

Important U.K.

This appliance is supplied with a 3-core cable for connection to a single phase 230-240 V 50 Hz supply.

The wires are coloured in accordance with the following code:

Green/yellow	= earth
Blue	= neutral
Brown	= live

In other countries check these details with your supplier.

WARNING
THIS APPLIANCE MUST BE
EARTHED.

IRL

The **voltage and rated load** are given on the data plate, visible when the oven door is open. Please ensure that these match the household mains supply.

The appliance is supplied with a 3-core cable for connection to a 230-240 volt 50 Hz supply.

The fuse rating is 16 amps for the "B"-model.

The wires are coloured in accordance with the following code:

Green/yellow = earth

Blue = neutral

Brown = live

WARNING
THIS APPLIANCE MUST BE
EARTHED.

ZA

Data relating to electrical connection will be found on the data plate, visible when the oven door is open. Make sure that these figures comply with the main voltage. Connection should be made via a suitable isolator which complies with national and local regulations.

The appliance is supplied with a 3-core cable for connection to a 230-240 volt 50 Hz supply.

The fuse rating is 20 amps for the "B"-model.

The wires are coloured in accordance with the following code:

Green/yellow = earth

Blue = neutral

Brown = live

WARNING
THIS APPLIANCE MUST BE
EARTHED.

Electrical connection AUS, NZ

All electrical work should be undertaken by a competent person in strict accordance with national and local safety regulations.

The voltage and rated load are given on the data plate, visible when the oven door is open. Please ensure that these match the household mains supply. Please quote these data, and the model and serial number when contacting the Miele Service dept.

Connection of this appliance should be made via a suitable isolator which complies with national and local regulations, and which is accessible after the appliance has been built in.

AUS:

The wall oven is suitable for connection to an a.c. single phase 240 V, 50 Hz electricity supply.

The fuse rating is 16 A.

NZ:

The wall oven is suitable for connection to an a.c. single phase 230 V, 50 Hz electricity supply.

The fuse rating is 16 A.

WARNING
THIS APPLIANCE MUST BE
EARTHED.

Test marks Electrical safety
. C-Tick Mark

Electrically suppressed
according to AS/NZS 1044

Installing the oven

To ensure adequate ventilation to the oven once installed:

- provide a ventilation cut-out in the housing unit as illustrated.
- do not fit a rear panel into the housing unit.
- do not fit insulation material inside the housing unit.

Important:

Remove the protective cork spacers from the sides of the oven before installation.

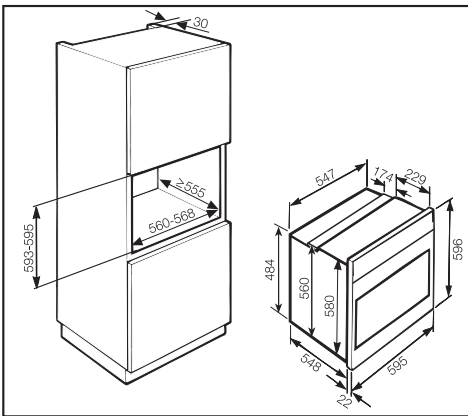

Turn off the mains electricity supply to the isolator.

- Connect the mains cable from the oven to the isolator.
- Push the oven into the furniture housing unit as far as the oven trim, and align it.

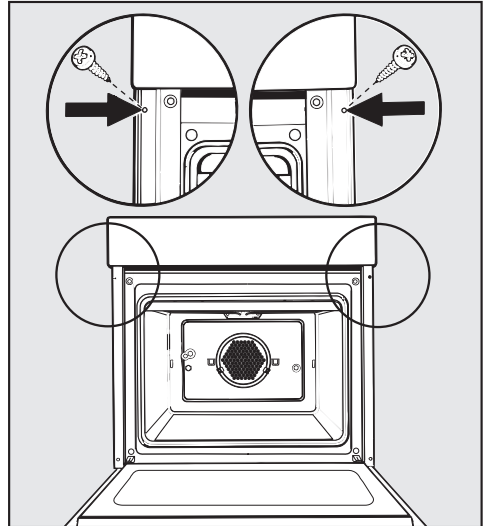

- Open the oven door, and with two screws secure the oven to the side walls of the furniture housing unit through the holes in the oven trim.
- Reconnect the electricity supply to the isolator.

The appliance must only be operated when it has been built in. Otherwise it poses an electric shock hazard.

United Kingdom:

Miele Co. Ltd.
Fairacres, Marcham Road
Abingdon, Oxon, OX14 1TW
Tel.: (01235) 554455
Fax.: (01235) 554477
Service Office Tel.: (08707) 554466
E-mail: info@miele.co.uk
Internet: www.miele.co.uk

Ireland:

Miele Ireland Ltd.
Broomhill Road, Tallaght, Dublin 24
Tel: (01) 46 10 710, Fax: (01) 46 10 797
Email: info@miele.ie
Internet: <http://www.miele.ie>

Australia:

Miele Australia Pty. Ltd.
A.C.N. 005635398
1 Gilbert Park Drive
Knoxfield, VIC 3180
Telephone: (03) 9764 7100
Fax: (03) 9764 7129
Internet: www.miele.com.au

Distributor New Zealand:

Steelfort Engineering Company. Ltd.
500 Rangitikei Street
Palmerston North, Priv. Bag 11045, NZ
Telephone: (06) 350 1350
Fax: (06) 356 1507

South Africa:

Miele (Pty) Ltd
63 Peter Place
Bryanston 2194
P.O. Box 69434
Bryanston 2021
Tel.: (011) 548 1900
Telefax (011) 548 1935
E-mail: info@miele.co.za
Internet: www.miele.co.za

Singapore:

Miele Southeast Asia
Miele Pte. Ltd.
163 Penang Road
04 - 02/03 Winsland House II
Singapore 238463
Tel : +65-67351191
Fax: +65-67351161
Email: infosea@miele.com.sg
Internet: www.miele.sg

Hong Kong:

Miele (Hong Kong) Limited
AIA Plaza, 24th Floor
18 Hysan Avenue
Causeway Bay
Hong Kong
Tel.: (852) 2610 1331
Fax: (852) 2610 1013
E-mail: mielehk@miele.com.hk